

*Osaki*

***Ai* SERIES 4D+3D**

Instruction Manual

4D Manhattan Duo Mech









# *Osaki*

Thank you for purchasing this product.  
Please read this manual carefully and thoroughly before using.  
Please keep this Instruction Manual properly on hand for future reference.  
This product is designed for home use.



# Contents

## Before Use

---

- Important Safety Instructions ..... EN4
- Grounding Instructions ..... EN9
- Product Parts ..... EN10
- Airbags Position and Numbers ..... EN11
- Things To Know And Do Before Use ..... EN12
- Side Panel Control Instructions ..... EN18
- Touch Screen Controller Instructions ..... EN20

## How to Use

---

- Operation Instructions ..... EN20
- Voice Control Instructions ..... EN44
- After Massage ..... EN45

## Maintenance

---

- Cleaning And Maintenance ..... EN46

## FAQ/Important Notes

---



- FAQ ..... EN47
- Troubleshooting ..... EN48
- Specification ..... EN50
- FCC Radiation Exposure Statement ..... EN51
- Industry Canada Notice ..... EN52

# Important Safety Instructions



Must be followed



These safety instructions must be strictly followed in use to avoid personal injuries and property damage :

■ All the safety instructions are described in compliance with degrees of the injuries or damage as a result of wrong use.

 <b>Warning</b>	Actions leading to cause serious injuries or death
 <b>Caution</b>	Actions leading to cause minor injuries or property damage

■ Pay attention to the symbols before safety instructions (an example is given below).

 Actions that are absolutely forbidden	 Actions that must be done
---	---

 <b>Warning</b>	
 <b>Must be followed</b>	<p>● <b>IMPORTANT SAFETY INSTRUCTIONS</b>                      When using this product, basic precautions should always be followed, including the following:                      Read all instructions before using (this product).</p>
	<p>● <b>DANGER-To reduce the risk of electric shock:</b></p> <ul style="list-style-type: none"> <li>• Always unplug this product from the electrical outlet after using and before cleaning.</li> <li>• Never use unauthorized parts or hardware for this chair. No modifications are allowed.</li> <li>• Carefully examine the covering before each use. Carefully examine the upholstery from top to bottom. If there are any signs of cracking, blistering, rethreading or tearing, stop using the product and contact the manufacturer for a replacement or further instructions. Please unplug the chair from the power outlet.</li> <li>• This product must be kept a climate-controlled area. 60-85 degrees Fahrenheit with very low moisture at ALL times.</li> </ul>
	<p>● <b>WARNING-To reduce the risks of burns, fire, electric shock or injury to persons:</b></p> <ul style="list-style-type: none"> <li>• An appliance should never be left unattended when plugged in. Unplug from outlet when not in use and before any authorized installs or alterations are being made.</li> <li>• Close supervision is required if you have any pets, children in the area when chair is being used.</li> <li>• Use this product only for its intended use as described in this manual. Do not use attachments not recommended by the manufacturer.</li> <li>• Never operate this product if it has a damaged cord or plug, if it is not working properly, if it has been dropped, damaged or dropped into water. Contact the manufacturer for examination and repair.</li> <li>• Never pull on any cables wire on this product.</li> <li>• Keep the cord away from heat source like a vent or a humid area like a bathroom.</li> <li>• If any the of the air hoses are plugged stop using the chair and contact the manufacturer and unplug power from the outlet.</li> <li>• Never allow for any object to fall into the chair or cracks of the chair.</li> <li>• This product is for indoor use only in a dry climate controlled area.</li> <li>• Do not operate where aerosol (spray) products are being used or where oxygen is being administered.</li> <li>• To disconnect, turn controls off then remove plug from outlet.</li> <li>• Keep children away from this product as working parts can seriously injure a child or pet.</li> <li>• Connect this appliance to a properly grounded outlet only. See Grounding Instructions.</li> <li>• Carefully Monitor the heating areas of the chair. If there is any abnormality or discomfort, turn off the chair, unplug the power from the outlet and contact the manufacturer.</li> <li>• Do not operate this product using a blanket or pillow. Excessive heating can occur and causing fire, electric shock or injury to persons.</li> <li>• Any elderly, handicap person, children (under 18) or with any person with a medical must consult with a medical doctor if this product can be used.</li> </ul> <p><b>SAVE THESE INSTRUCTIONS</b></p>
	<p>● <b>Any person with an implanted medical device or medical condition or under any treatment must get approval from your medical doctor before using this device.</b></p>

## ⚠ Warning

- |   |  |
|---|--|
| <ul style="list-style-type: none"> <li>(1) Any person with a pacemaker cannot use this product. The chair may cause an electronic malfunction to the medical device;</li> <li>(2) Patients with malignant tumors;</li> <li>(3) Patients with heart disease;</li> <li>(4) Person unable to feel or insensitive to heat on their skin such as a diabetic patient;</li> <li>(5) Pregnant women or ones that have just given birth;</li> <li>(6) Persons with poor blood circulation such as a diabetic patient;</li> <li>(7) Osteoporosis patients, spinal fracture patients or persons with acute painful disease or injuries such as joint sprains or muscle strains;</li> </ul> | <ul style="list-style-type: none"> <li>(8) Persons with any injuries should not use this product.</li> <li>(9) Persons with higher or lower regular body temperature, fever, inflammation, cold symptoms, high blood pressure or any poor health conditions should consult a physician before using this product;</li> <li>(10) Avoid falling asleep in this chair;</li> <li>(11) Any one with spinal or nerve conditions;</li> <li>(12) Persons with protrusion of intervertebral disc;</li> <li>(13) Do not wear loose clothing or jewelry as it might get caught with massage mechanism;</li> <li>(14) Keep long hair away from moving massage mechanism while in use.</li> </ul> |
|---|--|

Otherwise discomfort or even physical injuries may occur.



- **If you feel unwell while using or after using the chair, stop immediately and contact your physician. Do not use the chair again unless approved by your doctor.**

- **Before operating or adjusting the chair, be sure that there are no obstructions that can cause damage to your chair. No pets or persons, near, in front or under the chair to avoid serious injury.**

- **Before using the chair, look behind the backrest pad and inspect the area where the massage rollers travel up and down for any tearing or abnormal wear. Be sure the middle nylon cover is not unzipped and has no signs of damage or tear caused by the roller heads. Using the chair while the roller heads are exposed could cause physical injury, electrical shock or breakage.**

- **When using the chair for the first time, it is recommended that you select the “Demo” mode to get familiar with various massage features of the chair.**
- **Do not use the chair for more than 30 minutes each time.**
- **Do not massage a single part of your body for more than 5 minutes.**

**Failing to follow these instructions, discomfort or even physical injuries may occur.**

- **After using the chair, it is recommended that the chair is unplugged from the power outlet to avoid any surges caused by outages. It is HIGHLY ADVISABLE TO ALWAYS USE A SURGE PROTECTOR. Keep children or minors from using the chair without supervision to avoid misuse that could result in serious injuries.**

- **Follow the local code and regulations about use of electrical products.**
- **Use a 110V-120V, 60Hz power supply. (Do not use the chair in a country this product is not designed for or connect it with a transformer.) It may lead to electrical shock, product failure or internal components overheating causing fire hazard.**

- **Make sure the power cable is firmly plugged into the outlet to avoid power surges, short and electrical shocks. Electrical shocks may cause internal component overheating causing fire hazard.**

- **Wipe and clean the power plug regularly with dry cloth to avoid dirt or moisture built up.**



- **In the case of any abnormality with functions of the chair, stop using the chair immediately and pull out the power plug to avoid smoke, fires and electric shocks. Abnormality and fault examples are:**
- **If the chair is plugged in and the power switch is in the “ON” position and if the chair is not responding.**
- **When the chair is turned off but still operating.**
- **If you detect any burning smell or abnormal sounds.**
- **If you detect any parts of the upholstery that seemed to have melted due to over heating.**



— **In any of these listed issues have occurred STOP using the product and unplug from the power outlet. Have the product inspected by an authorized service center.**



- **Do not put any cushions or obstructions between the backrest pad and the backrest. This may damage the mechanism and result in personal injury.**

- **When moving or handling the chair, be sure to hold onto the recommended supported area. Otherwise parts of the chair may break resulting in serious injury.**

## **Warning**





 <b>Forbidden</b>	<ul style="list-style-type: none"> <li>● People with the following health issues should <b>NOT</b> use this chair: Persons for whom massage is not advisable by doctors. Such as persons with thrombosis, serious aneurysm, acute venous aneurysm, various skin inflammations (such as subcutaneous tissue inflammation) or various skin infections. Otherwise it may aggravate or cause serious injury.</li> </ul>
	<ul style="list-style-type: none"> <li>● Anyone with physical injuries or poor health should <b>NOT</b> use this product. Persons with acute lumbago, protrusion of intervertebral disc or displacement of a lumbar vertebra. Otherwise it may aggravate or cause serious injury.</li> </ul>
	<ul style="list-style-type: none"> <li>● Do not put hands, arms or feet into the traveling massage mechanism while the chair is operating.</li> <li>● Keep small children away from the chair. Climbing could result in falls that could lead to serious injuries.</li> <li>● Do not climb onto the backrest or the armrests.</li> <li>● Do not apply excessive pressure leaning back on the backrest.</li> <li>● Keep your head away from reachable areas of the backrest and the back cover.</li> <li>● Young persons or persons with physical disabilities that can not operate the chair on their own, should not use this product or without supervision. Anyone with weakened physical conditions should consult a doctor before using the chair.</li> <li>● When massaging the neck area, pay attention to the intensity of the massage and make sure it does not hurt the neck muscles or nerves.</li> </ul>
	<ul style="list-style-type: none"> <li>● Do not damage the power cord. Do not damage, alter, bend, twist or use it with any extension cords. Do not place the power cord close to a heater. A damaged power cord may result in electric shocks, short circuit or fires. Please consult with the retailer/dealer from which you bought the product or a designated authorized service center about maintaining your power cord.</li> </ul>
	<ul style="list-style-type: none"> <li>● When engaging the heat function of massage wheels, avoid prolong contact with the skin in one position. Otherwise low-heat burns may occur. Even if the temperature is relatively lower at 104°F~140°F, low-heat burns may happen in spite of no obvious hot or painful sensation.</li> </ul>
 <b>Wet-hand operation forbidden</b>	<ul style="list-style-type: none"> <li>● Do not insert or pull out the power plug when your hands are wet. Otherwise electric shocks may happen.</li> </ul>
 <b>Disassembly forbidden</b>	<ul style="list-style-type: none"> <li>● Do not refit, disassemble or repair the product without the help of an authorized service provider. Otherwise fires, abnormal movements or personal injuries may happen.</li> </ul>

## **Caution**

-   
Must be followed
- The following persons (even if they are physically healthy at present) should consult a physician before using the product.
    - (1) Persons with muscular atrophy;
    - (2) Persons with any spinal or back pain or spinal condition;
    - (3) Persons suffer from sprains or bruising easily;
    - (4) Persons with motion sickness;
    - (5) Persons who received a heart operation or another vascular operation.It may cause serious injury if not addressed properly. Otherwise, it may cause serious injury.
  - Before sitting on the product, make sure there is no foreign objects obstructing any part of the chair.  
(Make sure there are no foreign objects on the back cover, the backrest, the seat surface, the lower leg/foot massage section or inside surface of the back cushion.)  
Otherwise, accidents or injuries from product failure may cause serious injury.  
Before sitting on the seat, make sure the massage wheels are in the retracted positions.
  - Turn off the massage function before you get off the chair.
  - When the lower leg/foot massage section is not retracting after the massage, retract the footrest with the remote button.
  - When unplugging the chair, hold onto the head of the to plug and not the cord to avoid damaging to the power cord. Damaged cord could result in shock and serious injuries.
  - Before moving the chair, be sure the backrest is in the upright position and the footrest is retracted in default positions.  
Otherwise, injuries may happen or damage to the chair.
  - When moving the product by dolly, lay mats on the floor to avoid markings or damage to the floor. Do not roll the chair on engineered wood or soft wood floorings. Otherwise marks and damage may occur.
  - Keep the safety lock key.  
Keep children away the remote control.
  - Before moving the chair, make sure there are no obstructions around. If lifting is required, make sure to lift from the steel frame of the chair. Be sure to keep the chair in the upright position when lifting the chair when moving.
  - Symptoms such as skin inflammation, itching or swelling when using the chair, stop the using the product immediately and consult a physician.

-   
Forbidden
- Do not use the product with other electrical devices at the same time, such as a heating blanket.
  - Do not place your hands, arms, feet or any parts of your body to massage area that are not designed for the body parts to avoid discomfort or injuries.
  - Do not put the knees between the calf massager. This may cause serious injury.
  - Do not fall asleep while using the product.
  - Do not use the product after drinking alcohol.
  - If the airbag on the seat is not completely deflated, do NOT attempt to deflate the air bag by force or using any tools. Contact the manufacturer to resolve the matter.

## **Caution**

 <b>Forbidden</b>	<ul style="list-style-type: none"> <li>● Do not put hands or feet between footrest and seat base.</li> <li>● Do not put hands or feet between footrest and side panel.</li> <li>● Do not put hands or feet between seat base and side panel.</li> <li>● Do not put hands or feet between the upper and the lower part of the footrest.</li> <li>● Do not put hands or feet in the gap of seat base.</li> <li>● Do not put pets on the massage chair.</li> <li>● Do not pull out the power plug or turn off the power switch suddenly during massage operation.</li> </ul>
	<ul style="list-style-type: none"> <li>● Do not stand or sit on the backrest. This may lead to serious injury and damage to the product.</li> </ul>
	<ul style="list-style-type: none"> <li>● Do not stand or sit on the armrests.</li> </ul>
	<ul style="list-style-type: none"> <li>● Do not stand or sit on the lower leg/foot massage section or the footrest.</li> </ul>
	<ul style="list-style-type: none"> <li>● Do not drag or push the product after it is installed.</li> </ul>
	<ul style="list-style-type: none"> <li>● Do not move the product while there is a person sitting on it.</li> </ul>
	<ul style="list-style-type: none"> <li>● Do not use the product with other heating devices such as electric blankets. Otherwise fires may occur due to overheating.</li> </ul>
	<ul style="list-style-type: none"> <li>● Do not leave the remote controller on the seat, always return it to its holder.</li> </ul>
 <b>Wet-hand contact forbidden</b>	<ul style="list-style-type: none"> <li>● Do not place this chair in locations with high humidity such as the bathroom. Moisture will destroy electrical components resulting in product failure or worst, electrical shock and other serious injuries.</li> </ul>
 <b>Product wetting forbidden</b>	<ul style="list-style-type: none"> <li>● Do not use any liquid aerosol sprays around the chair. Otherwise, electric shocks, fire, short circuit or product failure may happen.</li> </ul>
 <b>Pull out the power plug</b>	<ul style="list-style-type: none"> <li>● Before cleaning or maintaining the product, always unplug the power cord.</li> </ul>
	<ul style="list-style-type: none"> <li>● In the case of a power failure, pull out the power plug at once. It is highly recommended to plug chair into a surge protector to protect the chair from shorting during outages.</li> </ul>
	<ul style="list-style-type: none"> <li>● When the product is not in used, pull out the power plug.</li> </ul>

## GROUNDING INSTRUCTIONS

This product must be grounded. If it should malfunction or break down, grounding provides a path of least resistance for the electric current to reduce the risk of electric shock. This product is equipped with a cord with an equipment-grounding conductor and a grounding plug. The plug must be plugged into an appropriate outlet that is properly installed and grounded in accordance with all local codes and ordinances. **Danger-Improper connection of the equipment-grounding conductor can result in a risk of electric shock. Check with a qualified electrician or serviceman if you are in doubt as to whether the product is properly grounded. Do not modify the plug provided with the product – if it will not fit the outlet, have a proper outlet installed by a qualified electrician.**

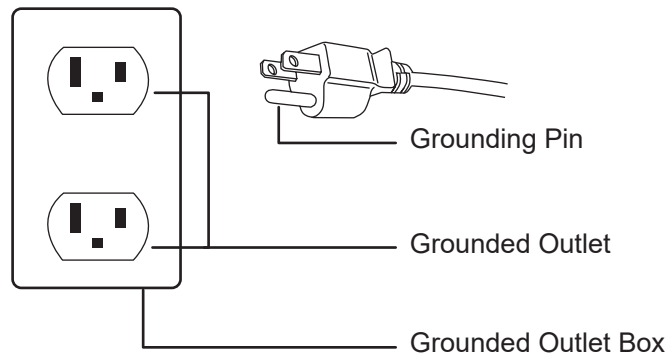

### Warning:

When using the massage chair, the arm should not be placed on the wireless charger. The minimum distance between the arm and the wireless charger is 80mm.

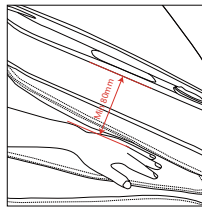

# Product Parts

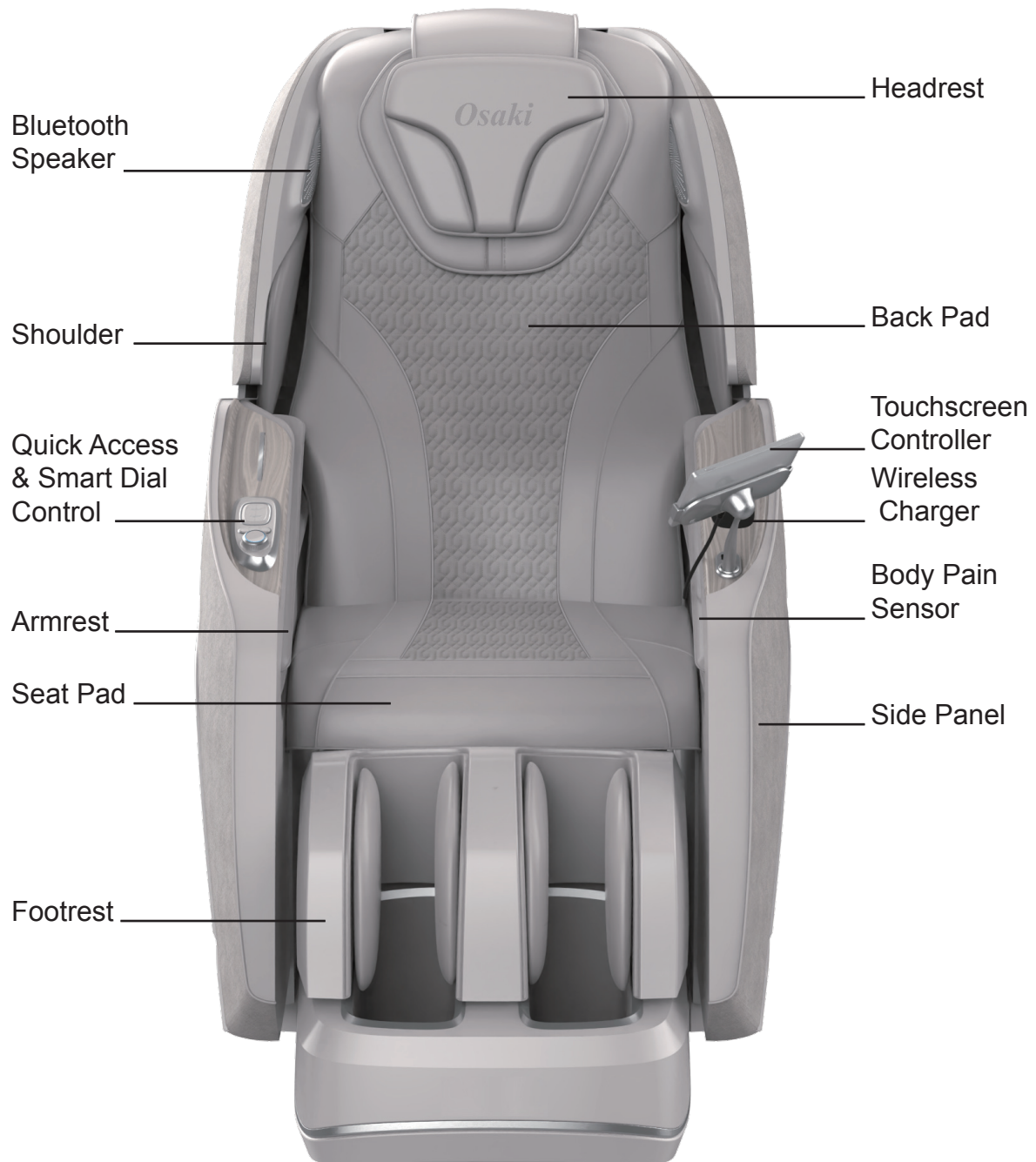

# Airbags Position and Numbers

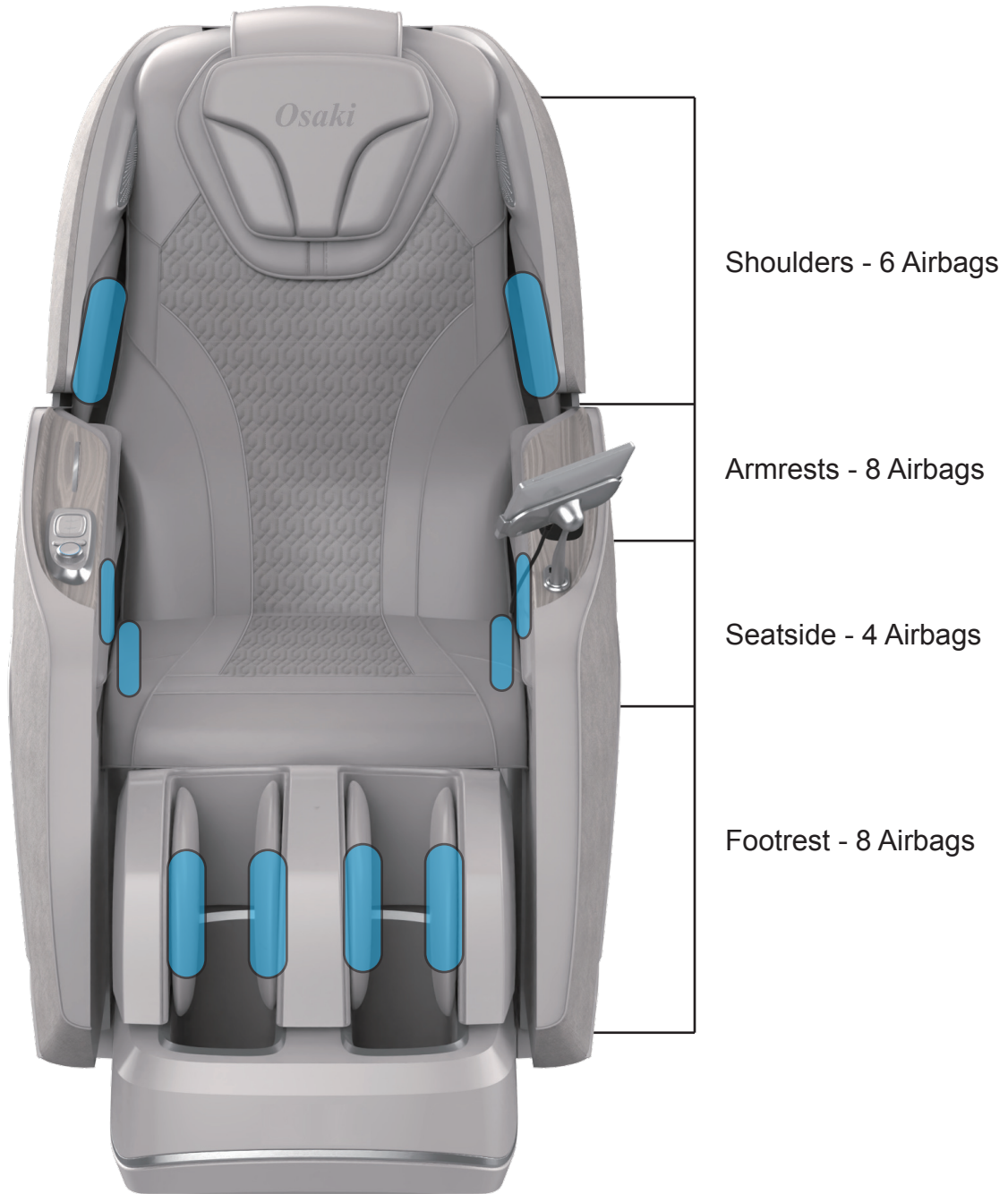

# Things to Know And Do Before Use

## 1 Footrest Installation

a) Take out the main unit, footrest and all the spare parts.

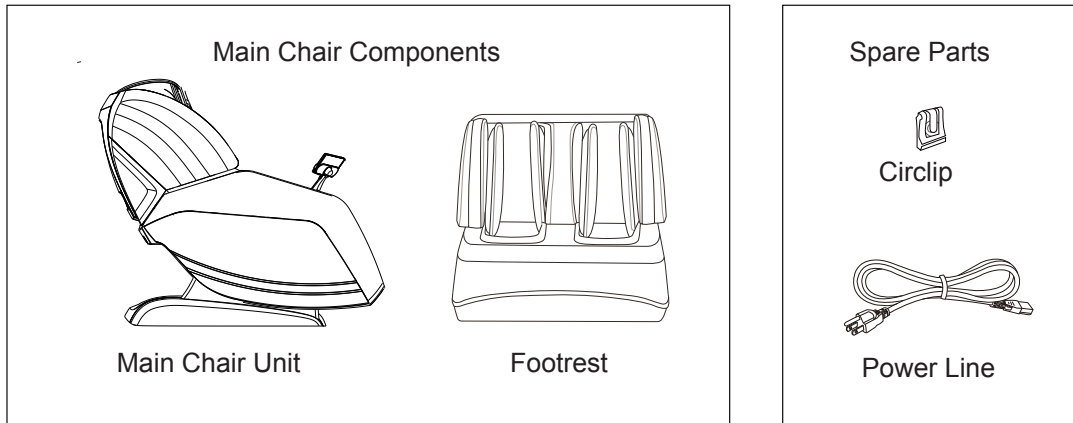

b) Connect the main unit and the footrest data line as well as the air hose.

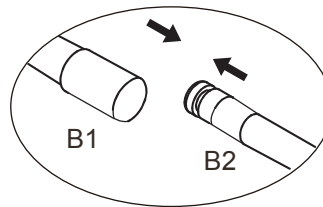
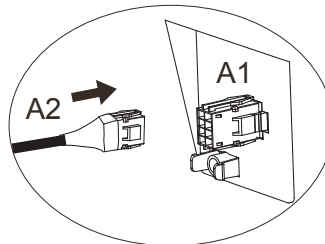
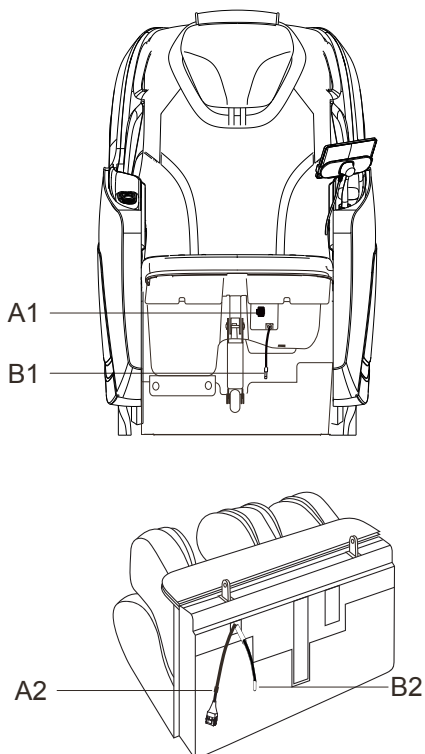

**NOTE:**  
When connecting the data line, please be sure to align up the arrow holes of the plug. Otherwise it will bend the pins and cause malfunctioning.

c) Insert H2 of the footrest into the corresponding pin shaft H1 of the main chair unit as shown below. Please be noted to first insert the longer pin shaft. And then insert circlip into the corresponding pin shaft slot again.

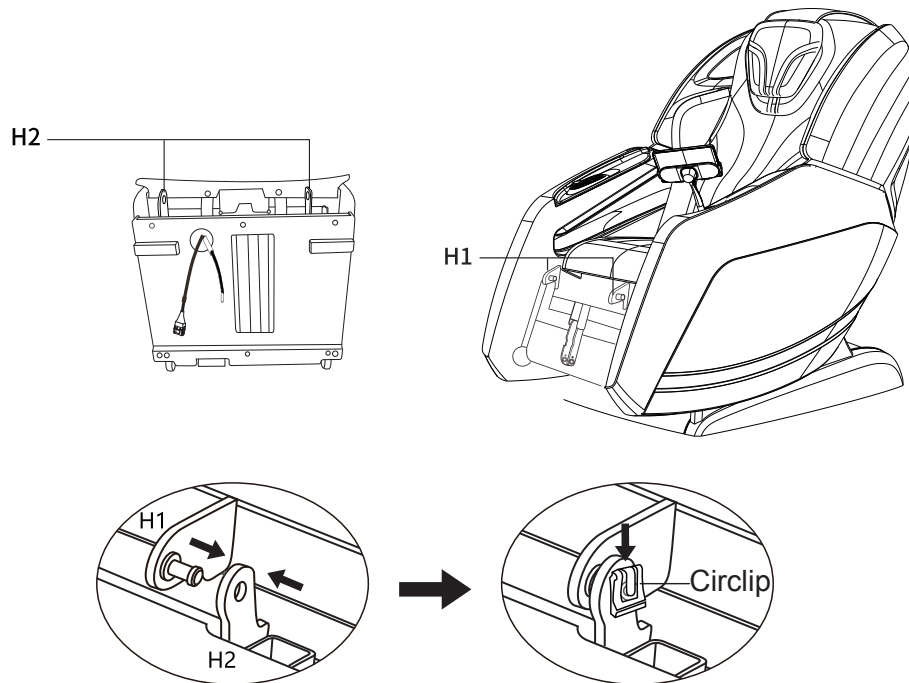

d) Zip up seat cushion to the footrest as shown below. Then complete footrest installation.

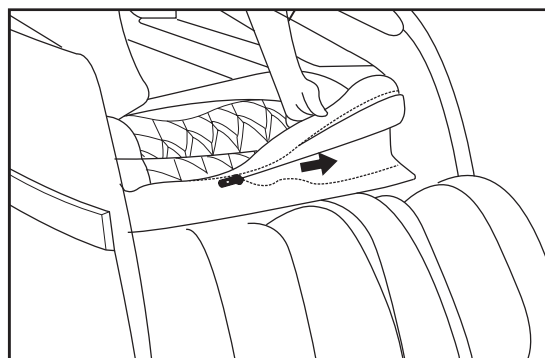

**NOTE:**

If you have the installation problems, kindly contact with your local service department for further help.

## Things to Know And Do Before Use

### 2 Place Position

- Before moving the chair, make sure it is powered off and nobody is using it.
- Since the chair is heavy, please be extra careful not to drop it. This may cause damage to the floor as well as the internal components of the chair.
- Place the chair in desired flat location nearing to the power outlet. Make sure there is enough room for the chair to recline and for the user to get in and out of the chair freely.
- Make sure to use a mat or rug under the chair if you place the chair on top of hard ground.

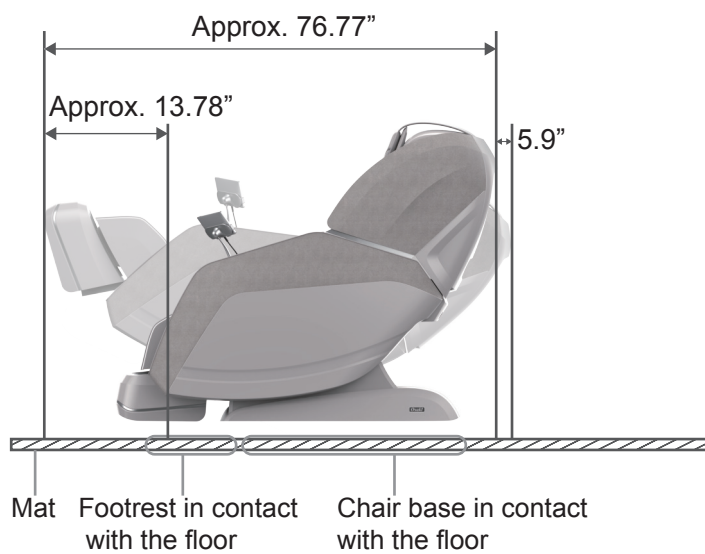

- Do not expose the product directly under the sunlight or in a high-temperature place (e.g., in front of heating equipment or by a window where sunlight can cause the synthetic leather fade, melt or crack.)
- Place a mat below the product to avoid floor damage. The mat should cover the product's area in contact with the floor and the footrest's area in contact with the floor (minimum dimensions: 63"x31.5"). See the figure.
- Install the product close to a power socket and keep distance from the footrest to the front for about 13.78" to make sure enough room for the footrest extension.

### 3 Inspect the Space Around the Chair.

Do not place or use the chair near individuals, animals, or any items that might interfere with the chair's functionality.



### 4 Ensure No Foreign Objects within the Seams of the Chair.

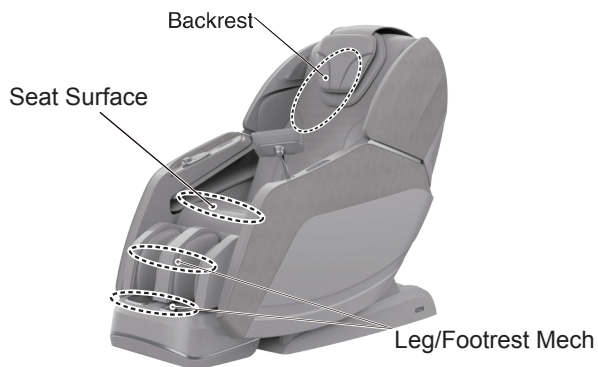

#### **Caution**

- Do not put hands or feet between footrest and seat base.
  - Do not put hands or feet between footrest and side panel.
  - Do not put hands or feet between seat base and side panel.
  - Do not put hands or feet between upper and lower part of the footrest.
  - Do not put hands or feet in the gap of seat base.
- Otherwise injuries may happen.

## 5 Examine the Power Cord & Electrical Plug

### Warning

- **Inspect the power cord of dirt or dust that may have collected. Be sure the cord is kept clean and with NO visible damage.**

Otherwise the lint and dust may lead to an electrical fire. Wipe down the plug with dry cloth.

- **Do not damage the power line or the power plug.**
- **Do not bend or twist the power cord for any reasons.**
- **Do not place the power cable under heavy objects such as the chair itself. Keep the power cord away from any heating sources such as the heater vents, motors and anything that may generate heat.**

A damaged power line or power plug may result in electric shocks, short circuits or fires.

Please consult the shop you bought the product or an authorized service center about maintenance method of the power line or the power plug.



Ensure the plug is fully inserted into the chair port, and keep the power cord untangled to prevent any potential damage.

## 6 Power on the Chair

- 1 Insert the power plug into the power outlet.
- 2 Turn the switch to the "I" (ON) position to activate the chair.

### Warning

- **Be sure the power cord is firmly and completely inserted into the power outlet.**

Otherwise electrical shocks or fires may occur because of overheating or power shorts.

- **Abide by the regulations on use of the socket and the wiring devices strictly.**

- **Use a 110-120V~, 50/60Hz power supply. (Do not use the product in a foreign country or connect it with a transformer without permission.)**

Otherwise electric shocks, product faults or fires because of overheat may happen.

- **Do not insert or pull out the power plug with wet hands.**

Otherwise an electric shock may happen.

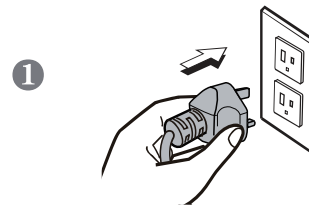

## 7 Ensure that the massage rollers are correctly positioned



If the rollers are not positioned correctly at the top of the backrest, press the "ON" button to reset them to the default position.

## 8 Ensure that the Fabric is Not Damaged or Cracked.

Examine the synthetic leather area where the massaging rollers move along the backrest, and make sure there is no damage or unusual wear.











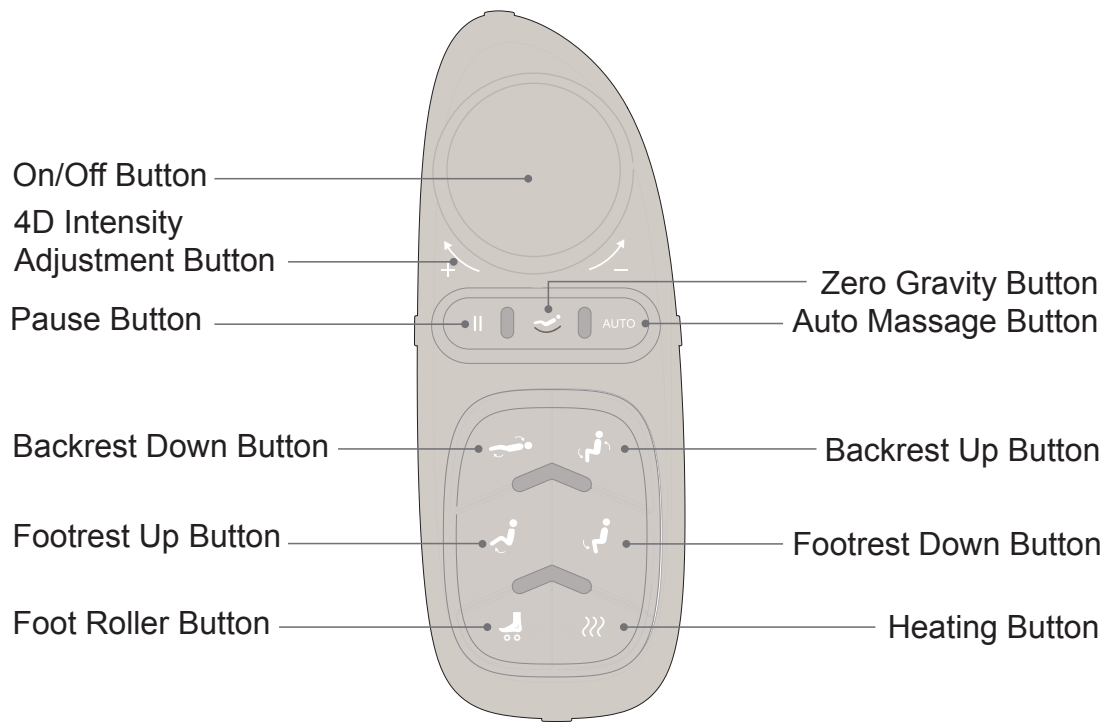



### Warning

- Before use, raise the back cushion and check whether fabrics lining pointed out in the figure are undamaged. Even if the fabric is slightly damaged, stop using the product immediately. Pull out the power plug and send notify the manufacturer for a replacement cover.

If the product is used when there is fabric damage, you may get injured or get an electric shock.

## Side Panel Control Instructions



	<p><b>On/Off</b></p> <ul style="list-style-type: none"> <li>• When in off state, press this button to turn the chair on; press it again to turn it off and chair will return to the original state.</li> </ul>
	<p><b>4D Intensity Adjustment Button</b></p> <ul style="list-style-type: none"> <li>• Increase the intensity by rotating the button in the clockwise direction and decrease the intensity by rotating counter clockwise.</li> </ul>
	<p><b>Pause Button</b></p> <ul style="list-style-type: none"> <li>• Press this button to pause the massage while press it again to continue massage.</li> </ul>
	<p><b>Zero Gravity Button</b></p> <ul style="list-style-type: none"> <li>• Press this button to enter zero gravity mode.</li> </ul>
	<p><b>Auto Massage Button</b></p> <ul style="list-style-type: none"> <li>• Press this button to enter the recommended auto massage program.</li> </ul>
	<p><b>Backrest Down Button</b></p> <ul style="list-style-type: none"> <li>• Press this button to recline the backrest.</li> </ul>
	<p><b>Backrest Up Button</b></p> <ul style="list-style-type: none"> <li>• Press this button to raise the backrest.</li> </ul>
	<p><b>Footrest Up Button</b></p> <ul style="list-style-type: none"> <li>• Press this button to raise the footrest.</li> </ul>
	<p><b>Footrest Down Button</b></p> <ul style="list-style-type: none"> <li>• Press this button to lower the footrest.</li> </ul>
	<p><b>Foot Roller Button</b></p> <ul style="list-style-type: none"> <li>• Press this button to turn on or turn off the foot roller function.</li> </ul>
	<p><b>Heating Button</b></p> <ul style="list-style-type: none"> <li>• Press this button to turn on or turn off the heating function.</li> </ul>

## Touch Screen Controller Instructions

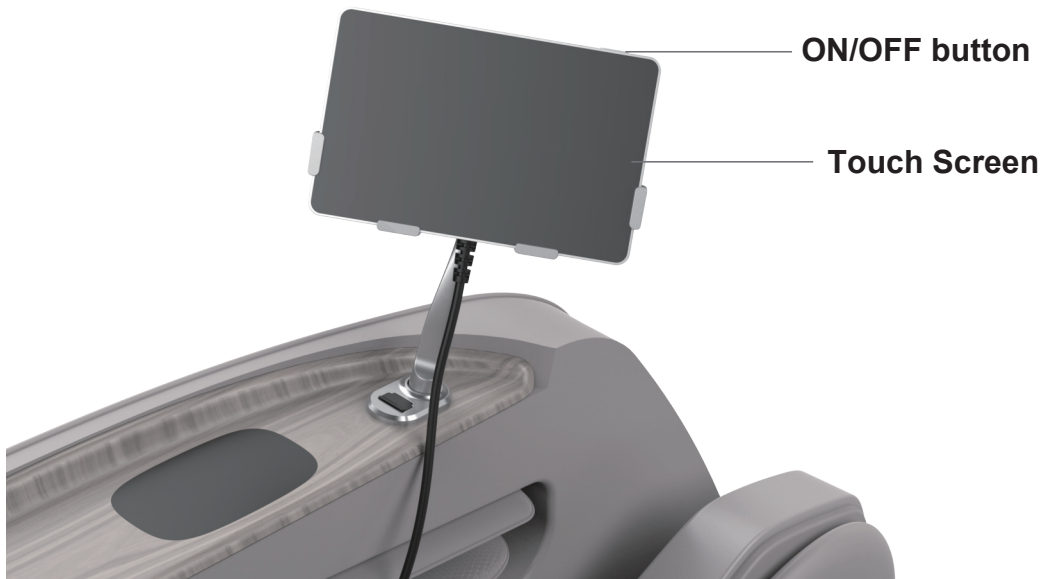

## Operation Instructions

### 1. Power On

3 ways to turn on the chair.

- I . By pressing the switch button on the upper right corner of the touchscreen controller.
- II . By pressing the power button on the smart dial control.
- III . By speaking the phrase “Hey Osaki” or “Hi Osaki” to wake up the chair. After the chair reponds, say “Power on” to start the chair.

When turning on the chair, you will see the chair brand “Osaki” showing up in the screen.

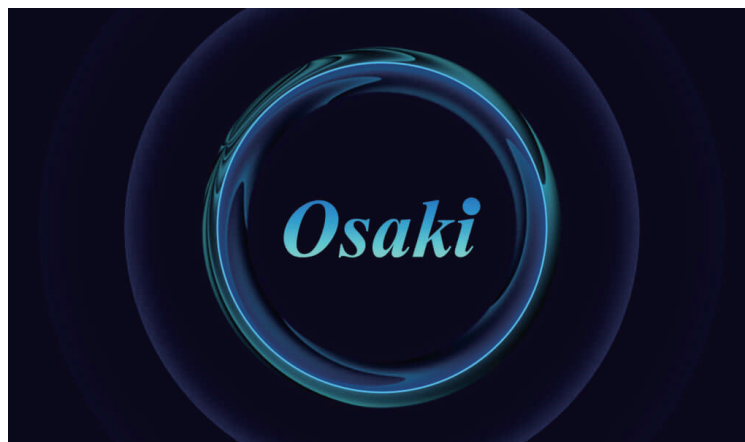

## 2. Home Page

After turning on the controller, you will see the home page showing like below.



Definitions:

- 1. Tourist Mode - This is personal center. Go to this mode to change your personal information. Or just leave it as 'Tourist Mode'.
- 2. Voice Control - This is where you can turn on/off the voice control and see the voice control commands and answers.
- 3. Pause - Pause the running massage program as you wish.
- 4. Auto Massage - Here are all the auto massage programs you can select from.
- 5. Custom Massage - You can customize your personal massage programs through here by choosing massage modes, combining massage techniques together with other functions.
- 6. Manual Massage - Here you can adjust the manual massage techniques from the both upper and the roller mechanisms.
- 7. Favorites - If you like some massage programs better, you can save them as 'Favorites'. It will save to your personal account number.
- 8. Pain Relief Massage - A body pain detection will occur first before the chosen massage begins. Please follow the instructions to complete the health check and then enjoy the massage that chair automatically present for you due to your health check data.
- 9. Seat Adjustment - You can adjust the backrest and footrest positions.

## 3. Personal Center

### a) Internet Setting

Before choosing a massage program, please first click the personal center on the home page for the internet settings. Select an available internet to connect.

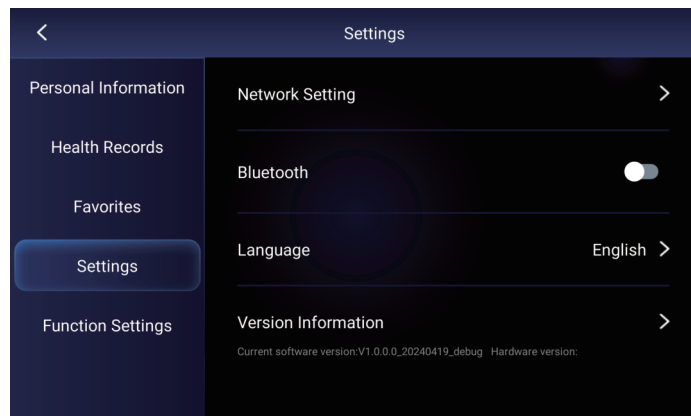

EN21

## b) Personal Account

When you tap to login to your profile, enter your email address and password to log in. Please click to register if you do not have an account. You may ignore these steps and click 'Vistor Mode Entry', you just want to enjoy the massage program. But chair will not save your personal information and health data curve so we would like to suggest you better log in with your personal account and find more fun with the chair.

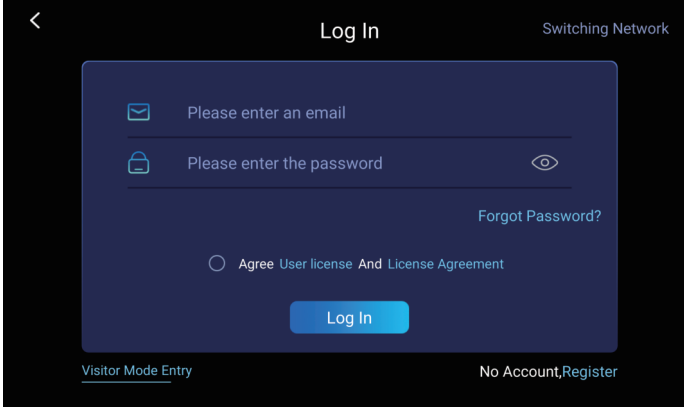

The screenshot shows the 'Log In' screen. At the top, there is a back arrow on the left, the title 'Log In', and 'Switching Network' on the right. The main content area is a dark blue rounded rectangle containing three input fields: 'Please enter an email' with an envelope icon, 'Please enter the password' with a lock icon and an eye icon for visibility, and a 'Forgot Password?' link. Below the fields is a radio button labeled 'Agree User license And License Agreement'. A blue 'Log In' button is at the bottom. At the very bottom of the screen, there are two links: 'Visitor Mode Entry' on the left and 'No Account, Register' on the right.

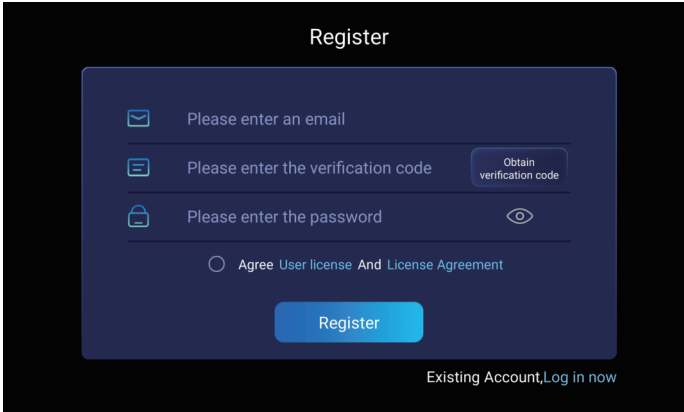

The screenshot shows the 'Register' screen. At the top, there is a back arrow on the left and the title 'Register'. The main content area is a dark blue rounded rectangle containing three input fields: 'Please enter an email' with an envelope icon, 'Please enter the verification code' with a document icon and an 'Obtain verification code' button, and 'Please enter the password' with a lock icon and an eye icon for visibility. Below the fields is a radio button labeled 'Agree User license And License Agreement'. A blue 'Register' button is at the bottom. At the very bottom of the screen, there is a link: 'Existing Account, Log in now'.

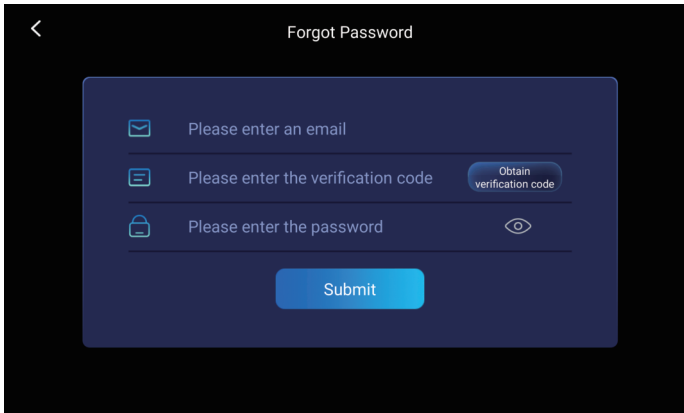

The screenshot shows the 'Forgot Password' screen. At the top, there is a back arrow on the left and the title 'Forgot Password'. The main content area is a dark blue rounded rectangle containing three input fields: 'Please enter an email' with an envelope icon, 'Please enter the verification code' with a document icon and an 'Obtain verification code' button, and 'Please enter the password' with a lock icon and an eye icon for visibility. A blue 'Submit' button is at the bottom.

NOTE: You may sometimes forget the password. Please fill in the corresponding information due to the requirement and submit and log in.

### c) Personal Information

After you login your account, you can see your personal information here, including your profile, email address, nickname, gender and height.

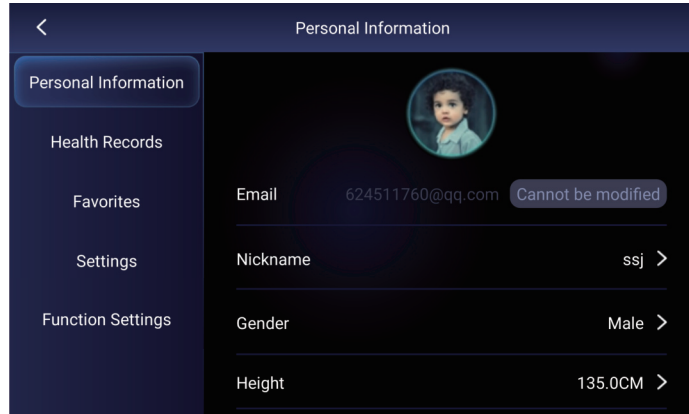

### d) Health Records

Here you can find the records on how many times you have used this massage chair and your health report as well as pain curve which is more intelligent and convenient to track. No data or records are stored until you use the chair. And please note that all the health data are just for reference only. If you still feel unwell, please consult your doctor.

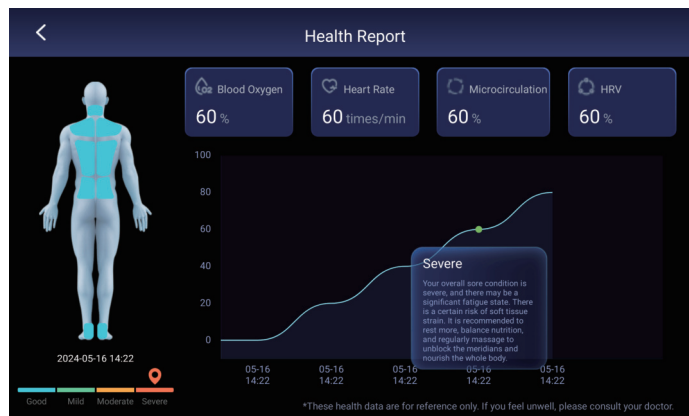
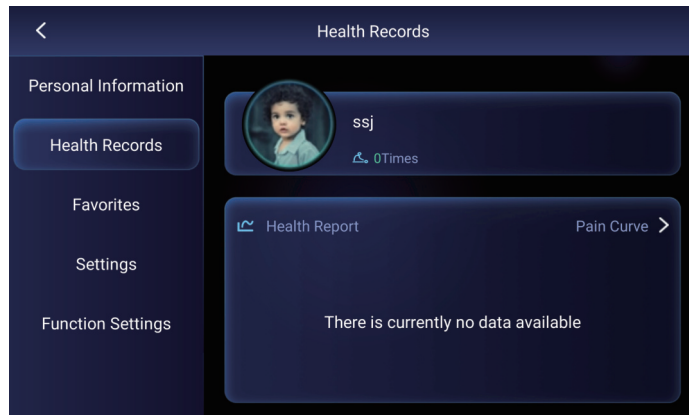

### e) Favorites

You will save your favorite massage programs here and you will click it directly to save to your favorites massages. If you would like to delete the favorites, please long press the according program icon a bit and delete it by the cross icon.

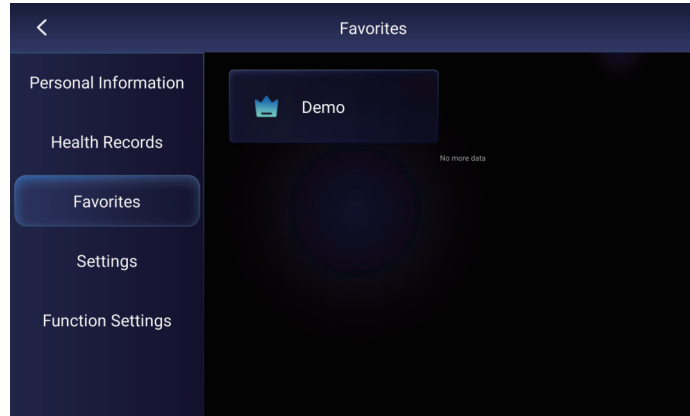

### f) Settings

Click 'Settings' to select internet, turn on or turn off the Bluetooth, change languages and update versions if necessary.

NOTE: When turning on the Bluetooth, please go to your device to connect "4D Manhattan" and then enjoy the Bluetooth music speakers as you like. Please make sure you disconnect the Bluetooth so the next user can use it.

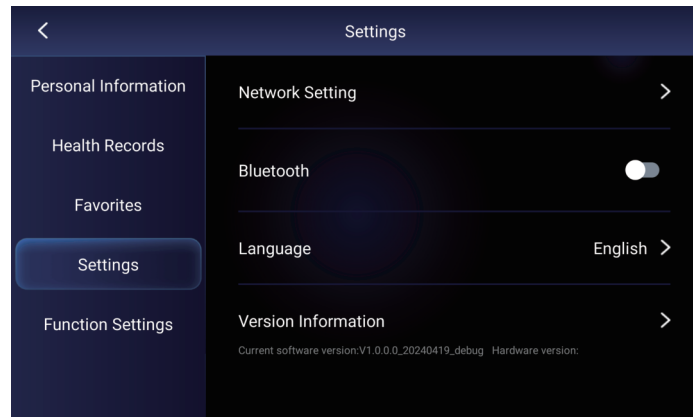

### g) Function Settings

Click 'Function Settings' to turn on or turn off the LED light as well as the touch volume. Also, you can adjust the auto sleep and brightness of the chair. And you can tap "One Key Auto Test" to see if all the chair functions run successfully.

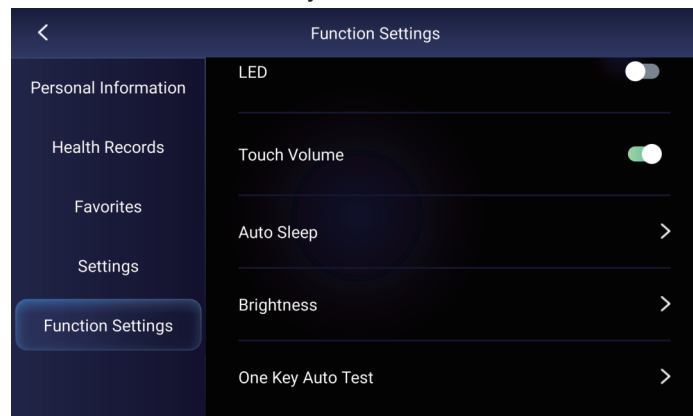

**NOTE:**

During “One Key Auto Test”, please do not sit on the chair to ensure all functions test smoothly and successfully.

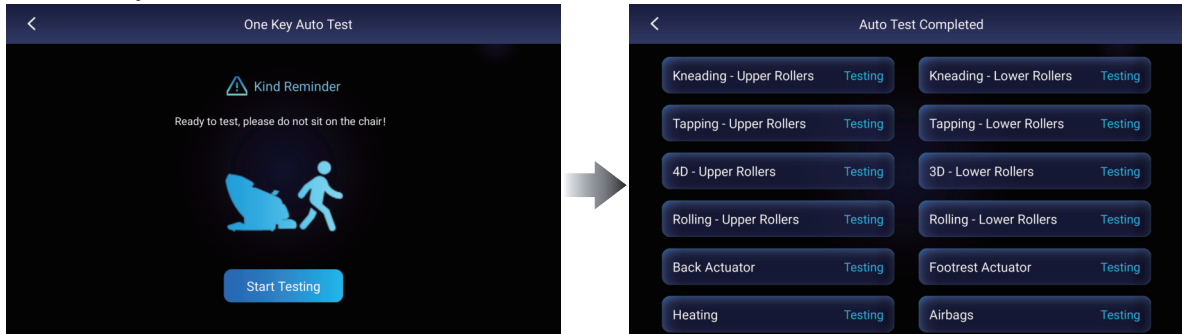

**4. Auto Massage**

- Click ‘Auto Massage’ on home page and choose one out of 16 auto massage programs to begin your massage program.
- Before the massage program begins, the chair will automatically conduct a body scan so please remove any watches, bracelets and other accessories before body scanning.
- Please also remove the pillow and sit as far back as you can in the seat to get a better and accurate shoulder detection.
- Please keep your posture still during the detection and make sure you get the proper shoulder position after scanning. Or chair will automatically enter the auto massage program that you choose in several seconds.



↓  
EN25

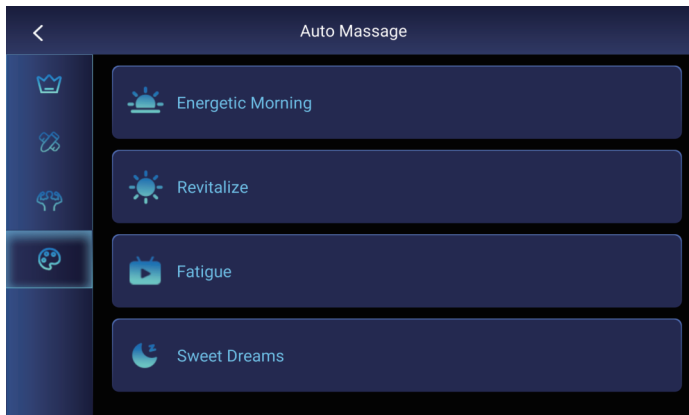
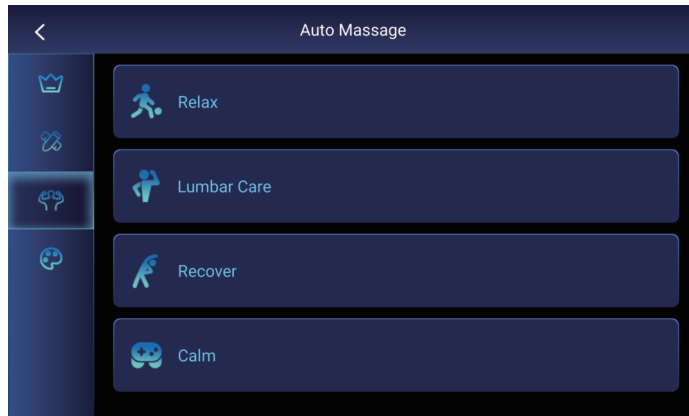
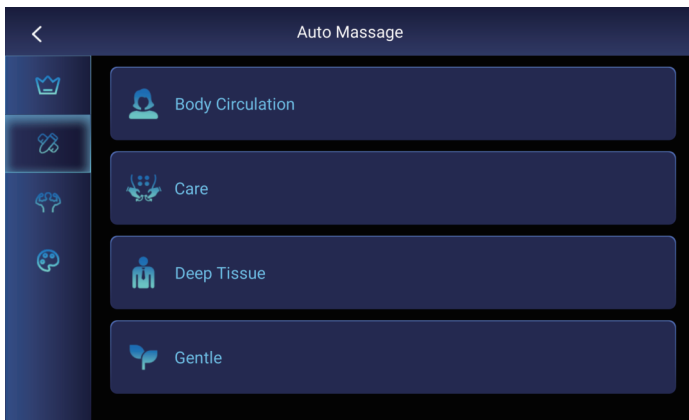
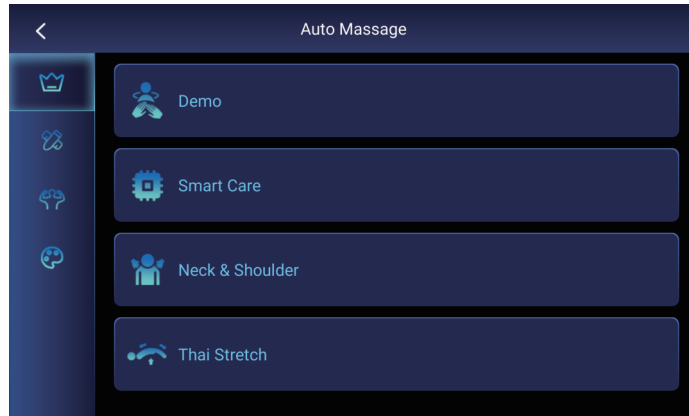

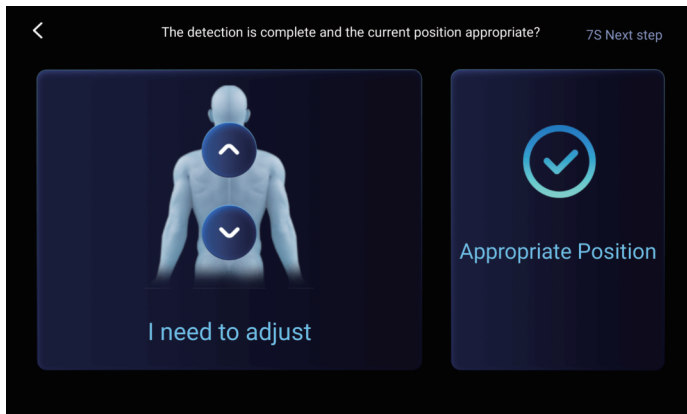
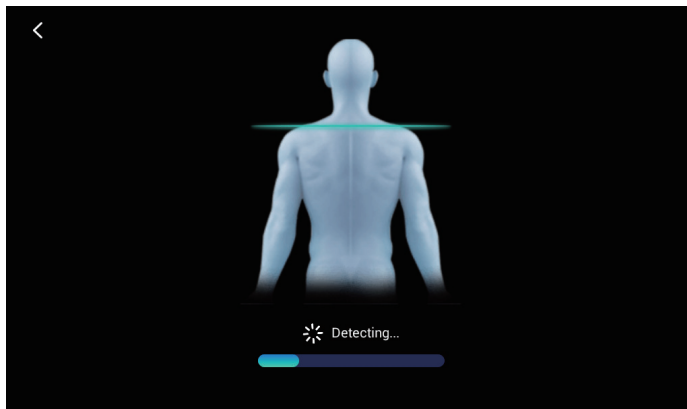
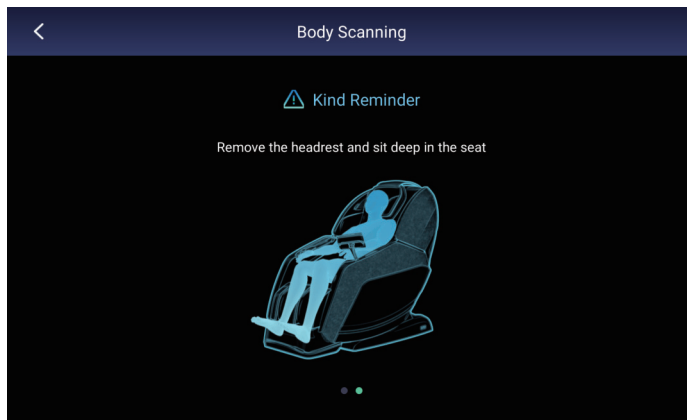
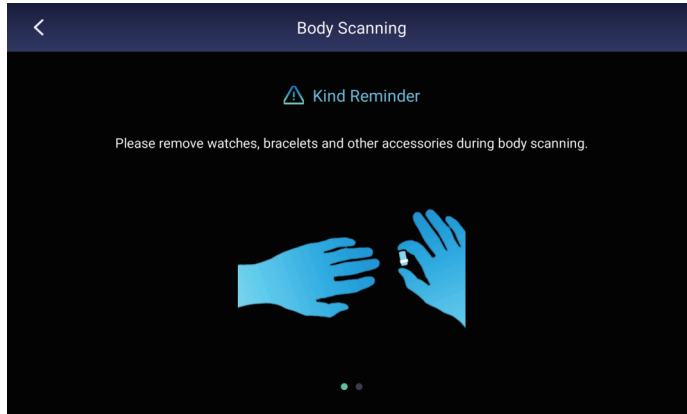







EN27

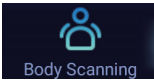
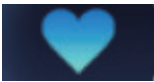

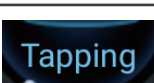
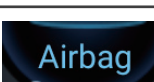

## Function Definitions

 <p>Body Scanning</p>	Click it to enter Body Scanning page.
	Favorite programs to save.
	Voice control.
	5 Adjustable levels of upper mechanism's intensity.
	5 Adjustable levels of lower mechanism's intensity.
	5 Adjustable levels of tapping massage. The icon will be light when having the tapping action or it will be grey.
	5 Adjustable levels of tapping massage. The icon will be light when having the tapping action or it will be grey.
	5 Adjustable levels of airbags' intensity.
 <p>Foot Roller</p>	Click it to turn on or turn off foot rollers function.
 <p>Calf Kneading</p>	Click it to turn on or turn off calf kneading function.



### Heating function to select

Tap to turn on lumbar & seat and calf heating on. If the parts are red, it means the heating is turned on. Tap again to turn it off.

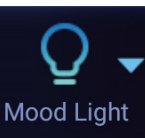
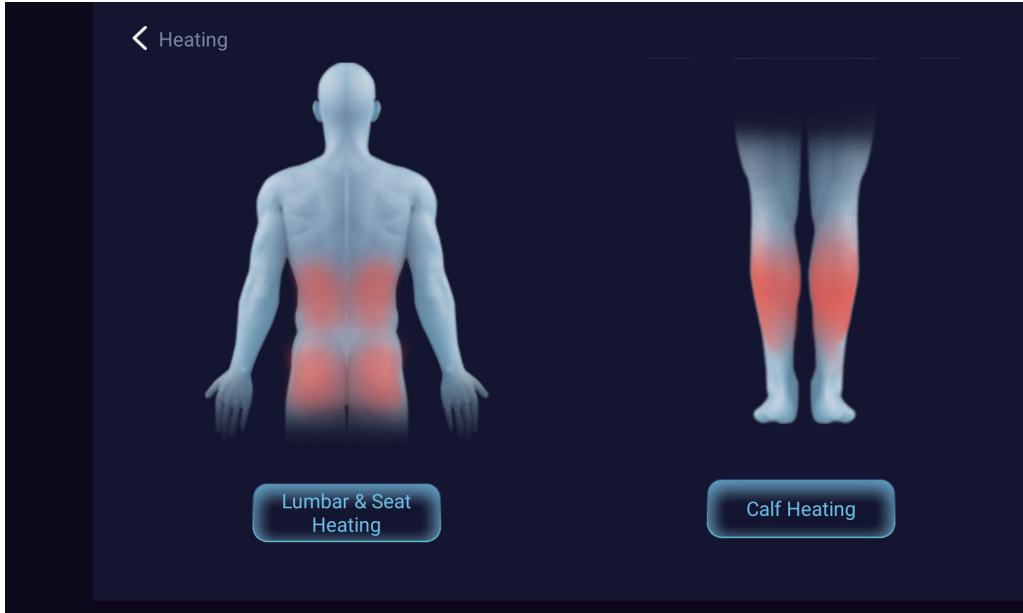





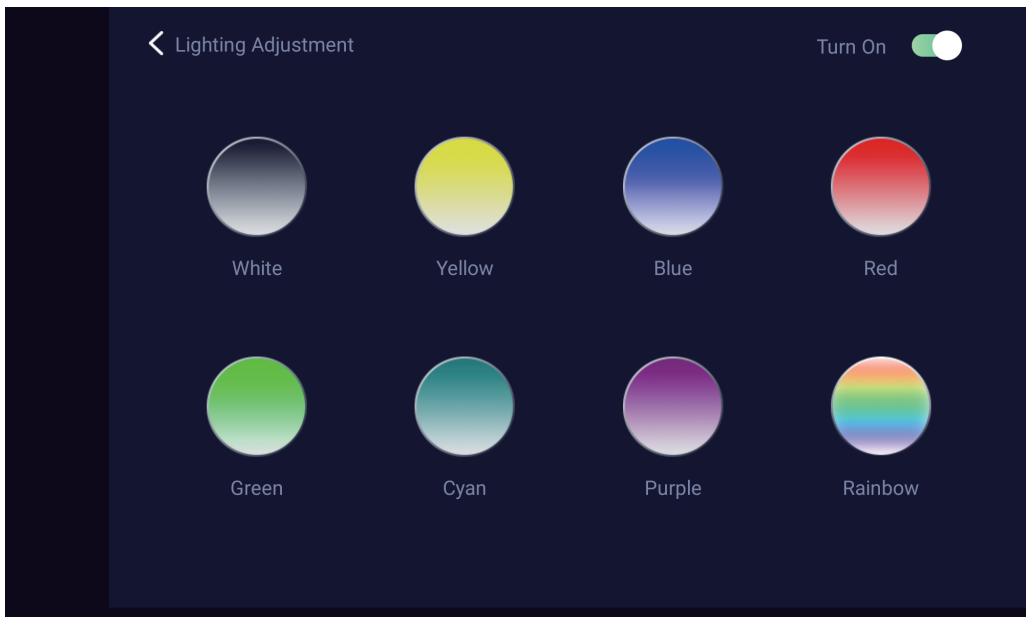











### Control the LED light as you want

8 colors for you to choose. Before you select any one of them, please make sure you turn the light on.



## Auto Massage Programs Definitions

Program Name	Definition
 Demo	This program is used for those whose lower back is tough and stiff and discomfort with back and legs.
 Smart Care	This program is used for daily personal care.
 Neck & Shoulder	This program is used for neck and shoulder care and pressure relief.
 Thai Stretch	This program is used for young and middle-aged people who like stronger massage like Thai stretch.
 Body Circulation	This program is used for people especially those women who just gave birth and blood circulation massage for them.
 Care	This program is used for men's care and pressure relieved by Chinese rolling massage mode.
 Deep Tissue	This program is used for neck and shoulder pressure relief and to help relieve dizziness and fatigue.
 Gentle	This program is used as elderly people's daily care massage.
 Relax	This program is used for those people who are fond of watching football games and helping them relax and relieve pressure.
 Lumbar Care	This program is used for lower back care massage.
 Recover	This program is used for before or after playing sports.
 Calm	This program is used for people who sit for a long time and help with body circulation.
 Energetic Morning	This program is used for morning wake-up massage.
 Revitalize	This program is used for noon care massage.
 Fatigue	This program is used for people who watch TV and to relieve any fatigue.
 Sweet Dreams	This program is used for helping people fall asleep better.

## 5. Manual Massage

- Click 'Manual Massage' on home page to enter the manual massage page.
- Before the massage program begins, the chair will automatically conduct a body scan so please remove any watches, bracelets and other accessories before body scanning.
- Please also remove the pillow and sit as far back as you can in the seat to get a better and accurate shoulder detection.
- Please keep your posture still during the detection and make sure you get the proper shoulder position after scanning. Or chair will automatically enter the auto massage program that you choose in several seconds.

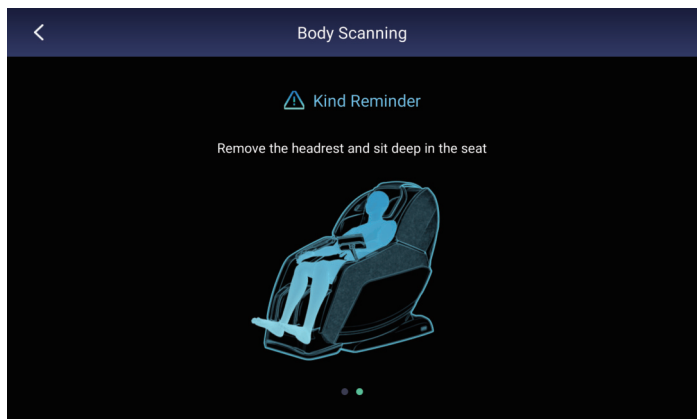
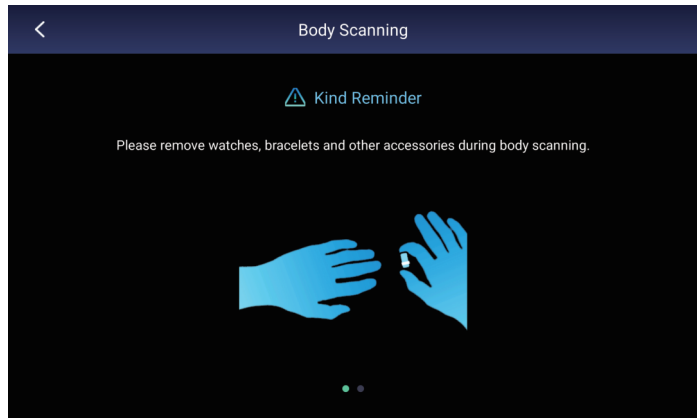

EN31



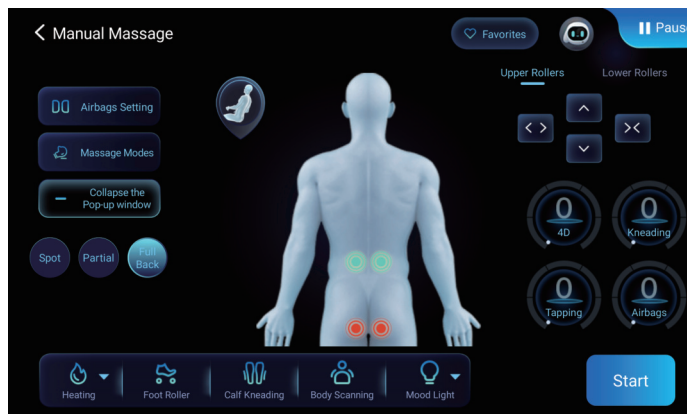
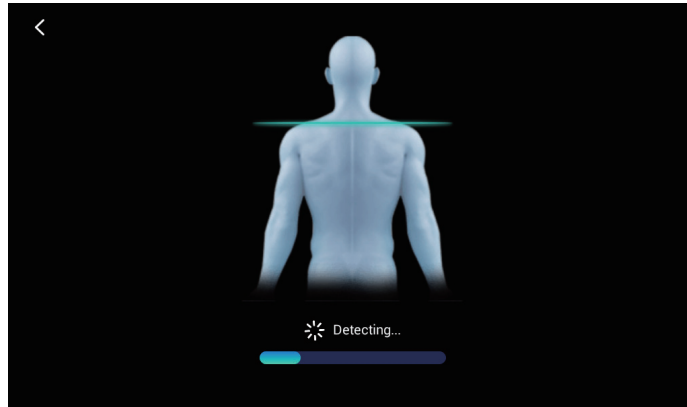
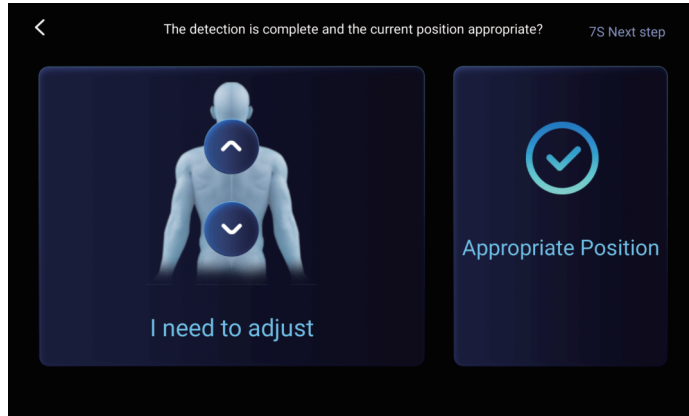

EN32

### a) Airbags Setting

Click 'Airbags Setting' to enter the interface, and select your desired parts for the airbags message. Click the setting button again to fold the popup window.



### b) Massage Modes

Click 'Massage Modes' to enter the interface. This chair has dual mechanisms to control. You can adjust both the upper mechanism and the lower mechanism accordingly. 7 single massage modes for each mechanism, Kneading, Shiatsu, Thumping, Tapping, Clapping, Rolling and Scrapping. Select any one of the single massage modes or combined massage modes of both mechanisms and click 'Start' button at the lower right corner to start massage.

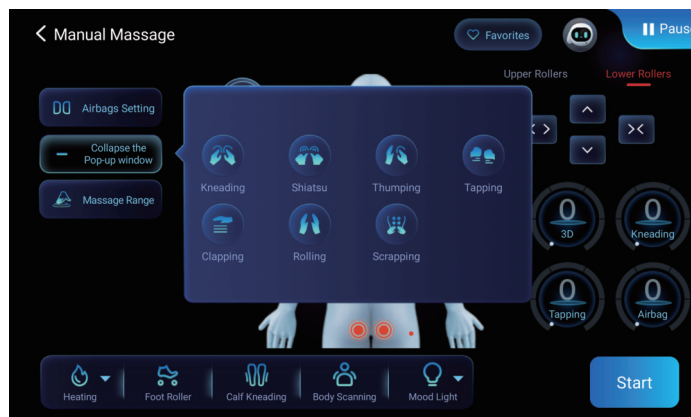
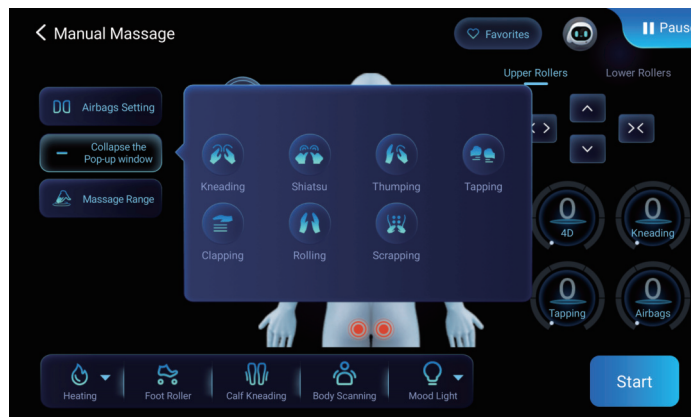

### c) Message Range

There are 3 options for you to choose, Spot, Partial and Full Back. Just select your desired range to start massage.

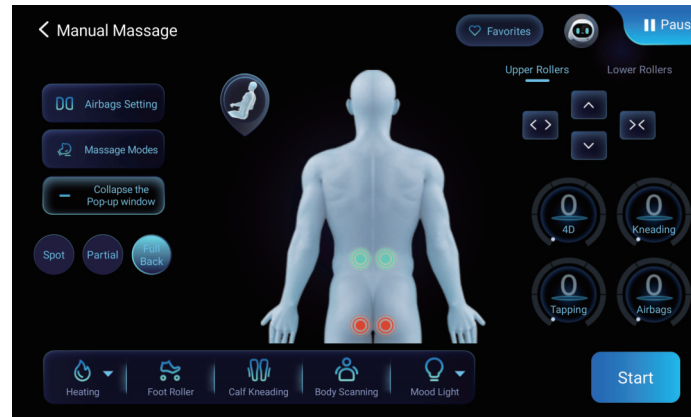

#### NOTE:

About the definition of each function on the Manual Massage interface, please refer to the 'Function Definitions' on page 28 to page 29.

## Manual Massage Techniques

Single Manual Techniques for Upper 4D Rollers	Kneading (I, II)
	Tapping (I, II)
	Clapping (I, II)
	Shiatsu (I, II)
	Thumping
	Rolling
	Scrapping
Combined Manual Techniques for Upper 4D Rollers	Kneading (I, II) X Shiatsu (I, II)
	Kneading (I, II) X Tapping (I, II)
	Kneading (I, II) X Clapping (I, II)
Single Manual Techniques for Lower 3D Rollers	Kneading (I, II)
	Tapping (I, II)
	Clapping (I, II)
	Shiatsu (I, II)
	Thumping
	Rolling
	Scrapping
Combined Manual Techniques for Lower 3D Rollers	Kneading (I, II) X Shiatsu (I, II)
	Kneading (I, II) X Tapping (I, II)
	Kneading (I, II) X Clapping (I, II)

## 6. Custom Massage

- Click 'Custom Massage' on home page and you will enter the according message page.
- Before your 1st time massage, chair will automatically body scan and please make sure you have removed watches, bracelets and other accessories before body scanning.  
And please remove the pillow and sit as deep as possible in the seat to get a better and accurate shoulder detection.
- After you finish the above steps, you will enter a page to choose your desired massage parts by sliding up and down of the screen. Then click 'Start' to enter the custom massage page.
- In the custom massage page, you can select a single massage mode or combined massage modes from both mechanisms and then click 'Start' to enjoy the massage.

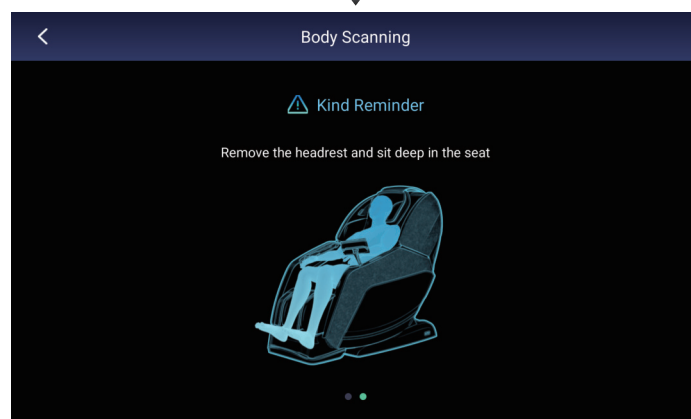
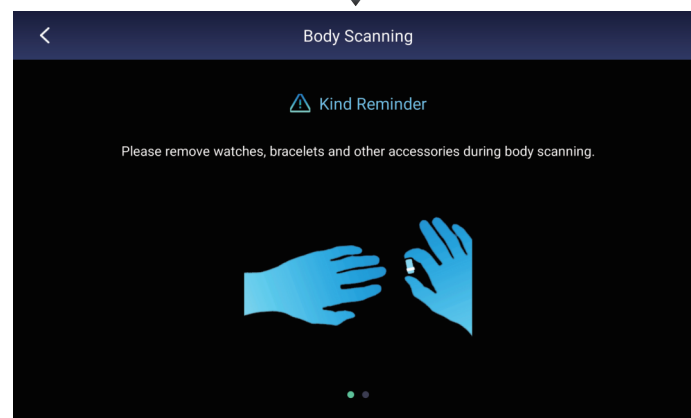
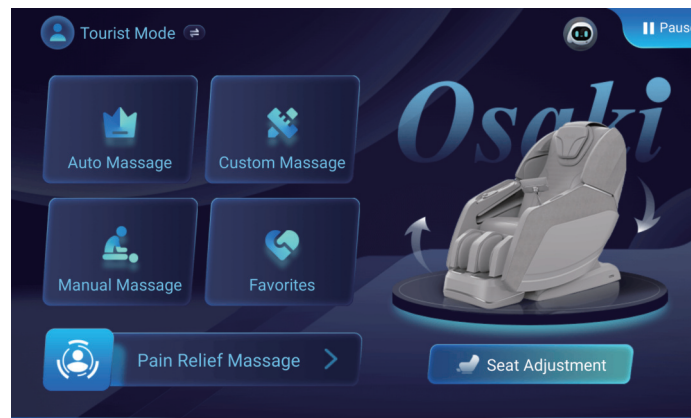

EN36

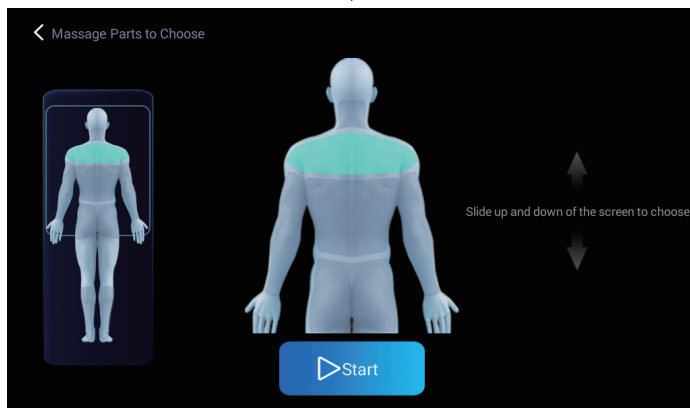
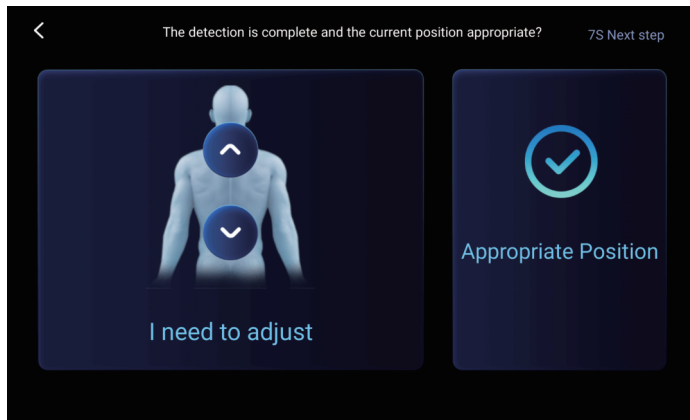
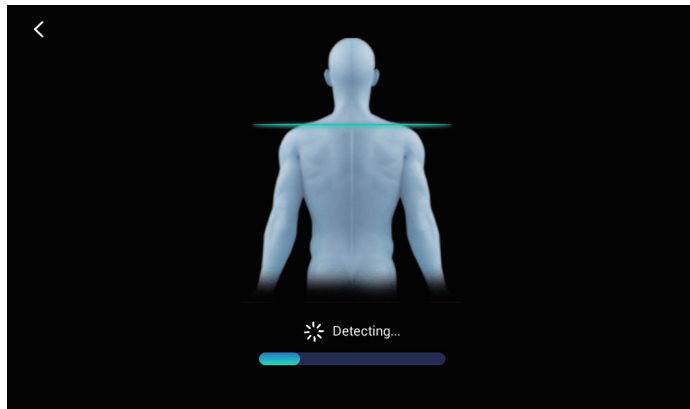

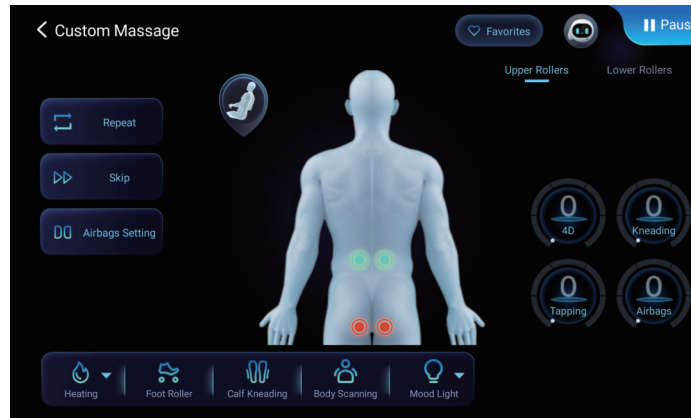

**a) Airbags Setting**

Click this button to select the airbags position.

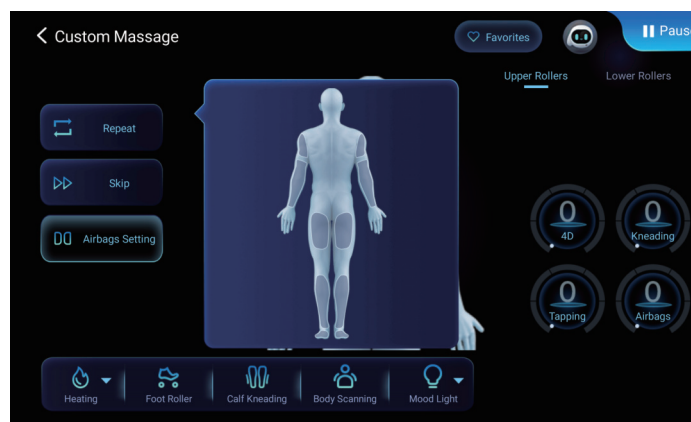

**b) Repeat**

Click the 'Repeat' button to repeat the action of the massage area. Click it again to cancel the repeating function.

**c) Skip**

Click the 'Skip' button to skip the massage in this area and proceed to the next area massage.

**NOTE:**

About the definition of each function on the Custom Massage interface, please refer to the 'Function Definitions' on page 28 to page 29.

## 7. Pain Relief Massage

- Click 'Pain Relief Massage' on home page and you will enter the according massage page.
- Before the massage program begins, the chair will automatically conduct a body scan so please remove any watches, bracelets and other accessories before body scanning.
- Please also remove the pillow and sit as far back as you can in the seat to get a better and accurate shoulder detection.
- Please keep your posture still during the detection and make sure you get the proper shoulder position after scanning. Or chair will automatically enter the the pain relief massage page in several seconds.
- After the above steps completed, please follow the guide in the interface to begin your health detection. Put your left hand close to the sensor in your left armrest and chair will automatically detect your health condition. Please do not leave your left hand from the sensor until it tells you that the health detection is completed.
- After the health detection, it will show results of your comprehensive health index, blood oxygen, heart rate, microcirculation and HRV. In total, there are 4 grades for the health index for your reference: 'Good', 'Mild', 'Moderate' and 'Severe'. You will also receive the suggestions accordingly about your health index.
- You can begin your recommended personal pain relief massage by clicking 'Start'. Otherwise, the massage will automatically start for you in several seconds.

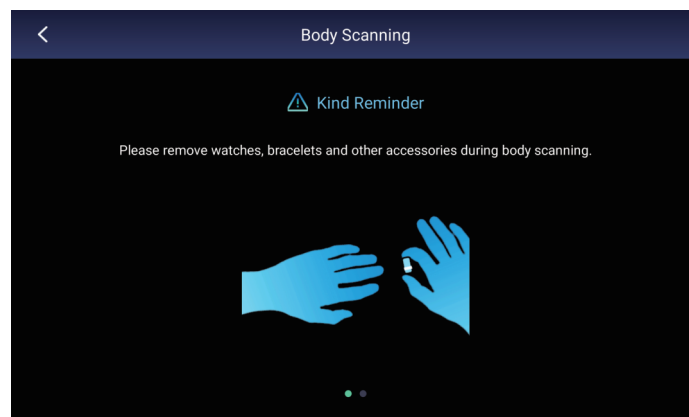
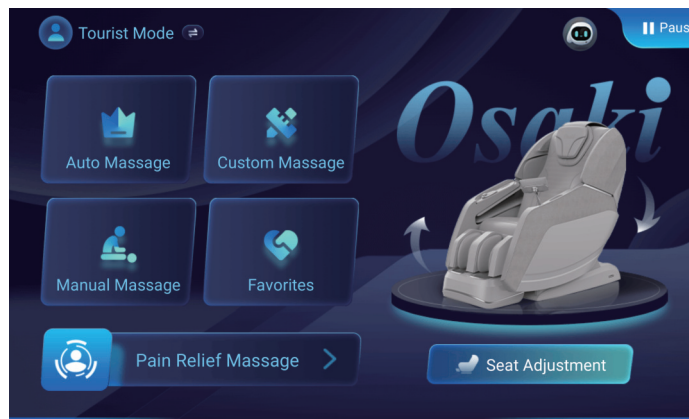

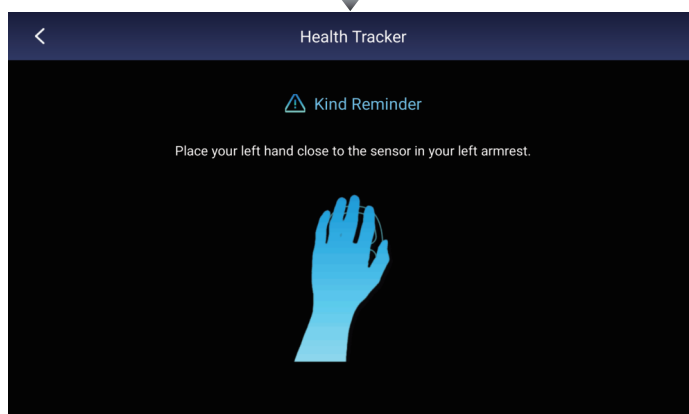
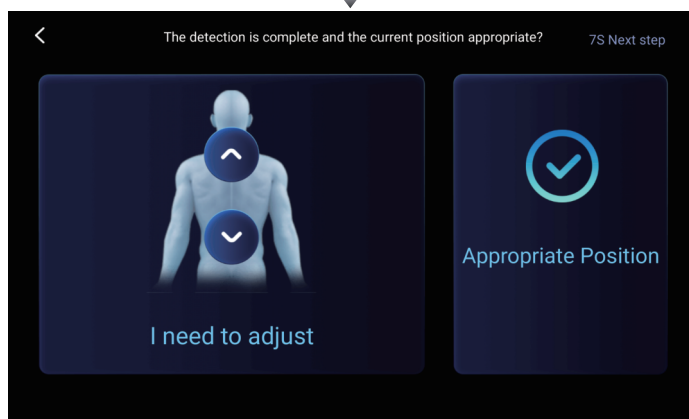
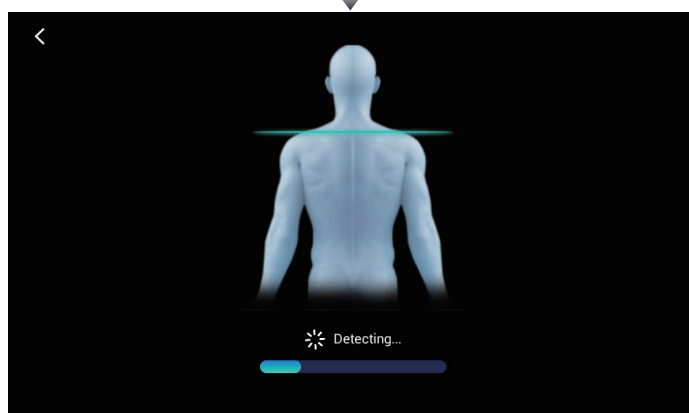
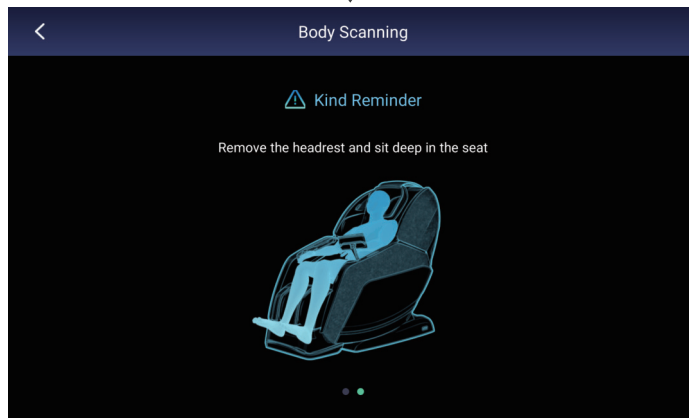

EN40

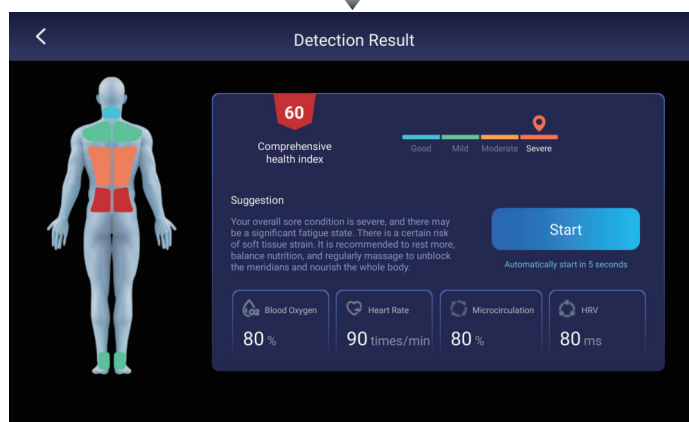
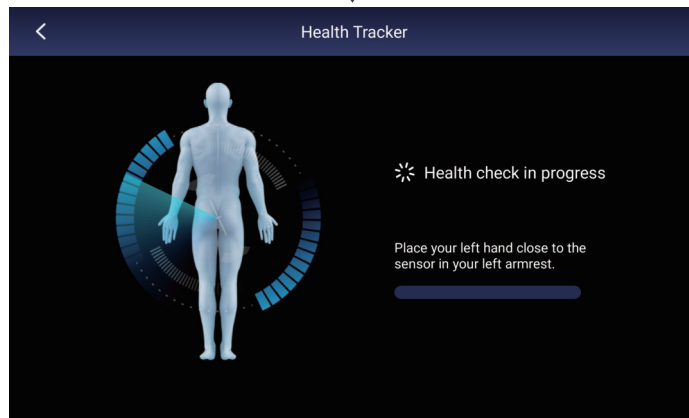

## 7. Favorites

- Click 'Favorites' on home page to view the favorited massage programs.  
You can click your favorite massage program directly through the page to have fun with it.
- If you dislike one or all of the favorite massage programs, you can long press the program names to delete them.

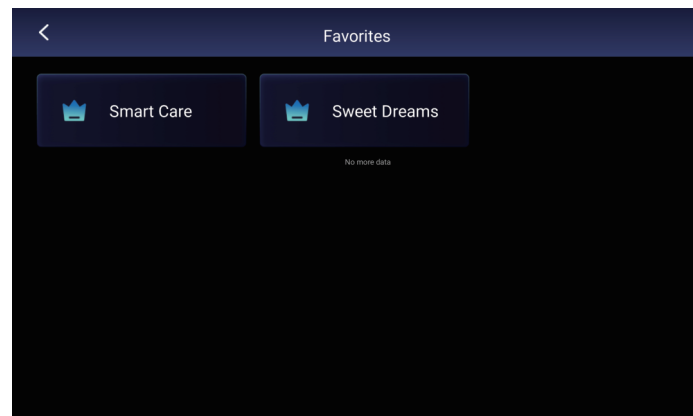

## 8. Seat Adjustment

- Click 'Seat Adjustment' on home page and you will enter a page showing how to adjust the chair.
- There are 4 zero gravity stages for you to choose from, Zero-G 1, Zero-G 2, Zero-G 3 and Open.
- Also, you can adjust the backrest and footrest by the up and down arrow icons per your personal preferences.
- Tap the "Reset" button to return to the original position state.

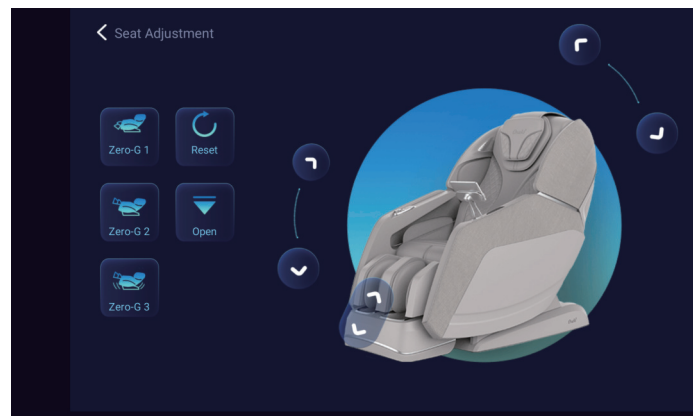
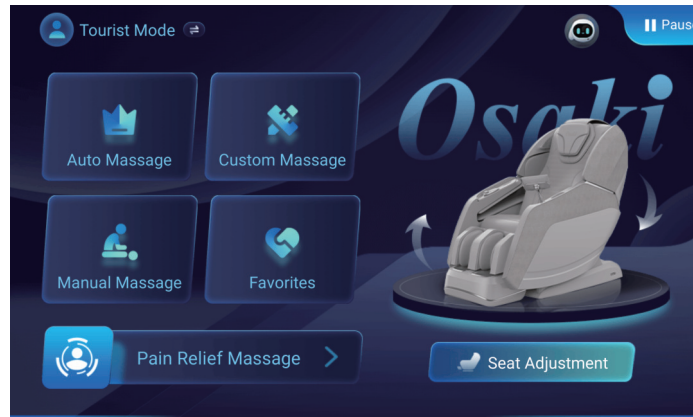

## 9. Pop-up Warning

- You may sometimes find a warning popping up like the below figure. Then you need to carefully check around the footrest area and make sure the object has been cleared.
- After the area has been thoroughly inspected, please press the "Clear" button to restart massage.

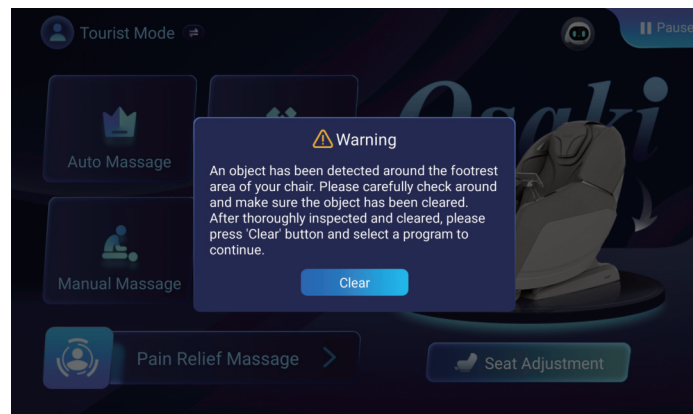

## Voice Control Instructions

- Turn on smart voice control in the settings before using.
- Near the right armrest, please say 'Hi Osaki' or 'Hey Osaki' to wake up the voice assistant.
- After you hearing the reponse "Yes, how can I assist?," Please say your next command to use the massage chair.
- Please note that the listening interval between each command is only for several seconds. Otherwise, you need to wake up the voice assistant again.
- It is also suggested to speak with a clear and loud voice so your command can be recognized.

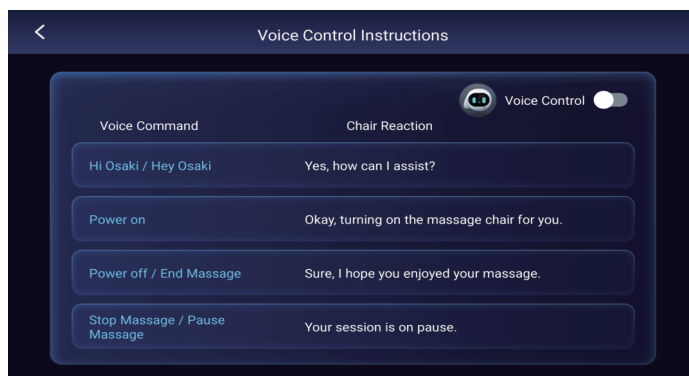

## Voice Control

User command	Chair Reaction
Hi Osaki / Hey Osaki	Yes, how can I assist?
Power on	Okay, turning on the massage chair for you.
Power off	Sure, I hope you enjoyed your massage.
End Massage	
Stop Massage	Your session is on pause.
Pause Massage	
Continue Massage	Resuming your session.
Raise a little higer	As you wish.
	I have reached the highest angle.
Lower chair a bit	As you wish.
	I have reached the lowest angle.
Stronger massage	Sure, increasing intensity.
	I have reached my maximum strength.
Decrease strength	Alright, decreasing intensity.
	Sorry, I am unable to go any lighter.
Switch on Back Heater	Turning on Back Heating.
Switch off Back Heater	Okay, turning off Back Heating.
Turn on Foot Roller	Turning on foot roller.
Turn off Foot Roller	Okay, turning off foot roller.
Switch on Calf Heating	Turning on Calf Heating.

Switch off Calf Heating	Okay, turning off Calf Heating.
Turn on all heating functions	Okay, we have enabled all heating functions for you.
Turn off all heating functions	Okay, we have disabled all heating functions for you.
Increase the volume	Okay, increasing the volume.
	This is the maximum volume.
Decrease the volume	Okay, decreasing the volume.
	This is the lowest volume.
Turn on the airbags massage	Okay, activating it for you.
Turn off the airbags massage	Okay, turning it off for you.
Smart massage	Okay, now starting the massage evaluation. Please press your left hand securely against the electrode pad in the armrest.
Change Massage	Ok, your wish is my command.
Demo massage	Ok, I have started the Demo massage.
Smart Care massage	Ok, I have started the Smart Care massage.
Neck & Shoulder massage	Ok, I have started the Neck & Shoulder massage.
Thai Stretch massage	Ok, I have started the Thai Stretch massage.
Body Circulation massage	Ok, I have started the Body Circulation massage.
Care massage	Ok, I have started the Care massage.
Deep Tissue massage	Ok, I have started the Deep Tissue massage.
Gentle massage	Ok, I have started the Gentle massage.
Relax massage	Ok, I have started the Relax massage.
Lumbar Care massage	Ok, I have started the Lumbar Care massage.
Recover massage	Ok, I have started the Recover massage.
Calm massage	Ok, I have started the Calm massage.
Energetic Morning massage	Ok, I have started the Energetic Morning massage.
Revitalize massage	Ok, I have started the Revitalize massage.
Fatigue massage	Ok, I have started the Fatigue massage.
Sweet Dreams massage	Ok, I have started the Sweet Dreams massage.

## After Massage

- 1 Turn off the power switch on the controller.
- 2 Pull the power switch to "O" position.
- 3 Pull out the power plug.



### Warning

- After using, it is recommended to put the power switch to the OFF position and pull out the power plug;  
Otherwise accidents and injuries by playing with them by children may happen.

# Cleaning And Maintenance

## Cleaning of the synthetic leather

Wipe the synthetic leather with a soft dry cloth.

- **Do not clean the product with solutions containing chemicals such as thinners, gasoline and alcohol.**
- **Be sure that leather cleaner will not harm the synthetic leather by reading the label.**
- **If the synthetic leather is very dirty, wipe it with the method below.**
  - ① Wet a soft cloth into water or 3% to 5% neutral detergent containing hot water and wring it out.
  - ② Be sure the soft cloth is well wrung out till there is NO water dripping from the cloth.
  - ③ Wipe surface of the synthetic leather with the soft cloth.
  - ④ Be sure to rinse out the cloth multiple times when wiping down.
  - ⑤ Have the synthetic leather dry naturally. Do not use dryer.
- **If it is difficult to remove the stains on the synthetic leather, try soak a piece of melamine foam into a neutral detergent to wipe down several times.**
- **Do not dry the surface by a hair dryer.**
- **Surface of the synthetic leather may fade or discolor if an inappropriate detergent is used. Test the cleaning solution in small section prior to fully applying.**
- **Do not clean the hard plastic parts with any alcohol, thinner or benzine based agents. This may cause discoloring or removal of the color all together.**



## Cleaning of the plastic parts

**1** Put a piece of soft cloth into water mixed with a neutral detergent contained hot water, wring it out and wipe the plastic parts.

- Do not clean the product with chemicals such as thinners, gasoline and alcohol.

**2** Wipe down with a microcloth or soft cloth wrung out in clean water.

- Be sure the cloth is well wrung out with no water dripping, leaving the cloth damp.

**3** Have the plastic parts dry naturally.



## Frequently Asked Questions (FAQ)

**Q** Can someone with a medical condition or disease use this product?

**A** They must consult with their physicians before using the product.

Massage can aggravate or worsen muscle injuries, bone disease, spinal abnormalities, skin disease and kill ones with medical devices implanted in their body.

**Q** Is there a restriction body height and weight to use this chair?

**A** The recommended min. height is 4'9" with a max. height of 6'4". The max. weight capacity is 260 lbs.

If the user is shorter or taller than the height range, They will not fit comfortably in the chair and may even experience injury. The maximum weight limit must be followed to avoid damaging the chair and also possibly seriously injuring yourself while using the device. The limits are in place for the users safety.

**For a taller person with knee bending when using the product:**

Tilt the backrest and lower the Lower Leg/Foot massager to the down position, elongating the length from top to bottom.

**For a short person difficult to touch the foot massage section:**

Raise the backrest and raise the legrest to shorten the distance from the top to bottom.

**Q** Where is serial number of the product?

**A** It is located at behind the backrest at the back of the chair by the power cord.



**Q** When I use the chair it makes noise .

**A** It is part of the normal function of the chair.

The chair is equipped with an air pump and multiple motors. The sounds are part of chair when being operated.

**Q** How long should I use the massage chair each day?

**A** 20 minutes per day with no medical conditions.

For the 1st week of using the chair, use only for 20 minutes at most assuming the user is in good medical condition. If there is any discomfort, stop using and consult with your doctor. In the first few days of using, you may experience mild soreness. Be sure to monitor the pain levels and if the soreness does not diminish after the following days, consult with your doctor before using again.

**BE SURE TO DRINK PLENTY OF WATER AFTER EACH MASSAGE.**

# Troubleshooting

**If an issue occurs, inspect and trouble shoot according to the corresponding method below.**

If the problem is not solved, contact the manufacturer for further instructions or service.

Fault	Cause and elimination method
<p><b>The massage wheels stop during use</b> (The product beeps and all icons and buttons on the remote controller flicker and then go out.)</p>	<p><b>As a safety protocol the massage heads will stop if pressure/weight load has exceeded its limit.</b></p> <p>To avoid potentially over heating or damaging the massage mechanism the chair is designed to automatically shut off if over strained or over heated. The remote will flash a few times and then shut off as a safety measure. If this has occurred turn off the power switch from the back, allow for 30 sec. And power back on. If the weight capacity of 260 lbs is not exceeded, unplug from the outlet and notify the manufacturer.</p>
<p><b>The product cannot tilt, or the footrest cannot be raised or lowered</b> (The product beeps, the running light on the remote controller go out and the product stops)</p>	<p><b>This product will stop upon any obstruction or a too large of a force preventing from operating.</b></p> <p>If all screen and buttons are flickering and the backrest or the footrest has stopped, turn off the power supply and turn back on 10 seconds. Be sure there are no obstructions in the way of the footrest or the backrest rolling mechanism.</p>
<p><b>The massage wheels cannot reach the shoulders or the neck</b></p>	<p>If your head is not properly placed against the backrest during the computer body scan, it may result in an incorrect reading, causing the rollers to start a lower position causing the massage to be inaccurate. If this occurs turn off the power from the remote and start over again to get a proper reading.</p>
<p><b>The left and right massage wheels have different heights (intensities)</b></p>	<p>This is a normal function of the massage mechanism as it programmed to massage alternating locations from the right side during certain intervals of the program.</p>
<p><b>The chair is not functioning (massaging).</b></p> <ul style="list-style-type: none"> <li>● Upper body (the neck to the waist) massage</li> <li>● Lower leg/foot massage</li> </ul>	<ul style="list-style-type: none"> <li>● The power line is disconnected.</li> <li>● The power switch is not turned on.</li> <li>● If no program is selected after turning, the chair will pause and shut down. Turn off and restart.</li> </ul>
<p><b>The roller heads are still warm after turning off the heat or the product is damaged.</b></p>	<ul style="list-style-type: none"> <li>● Because the roller heads heat up it will take some time for the residual heat to dissipate.</li> <li>● If the massage heads are mildly warm, the rollers may be admitting heat created by the friction from the massage.</li> </ul>
<p><b>The power line or the power plug is abnormally warm to hot.</b></p>	<p>To avoid accidents, contact an authorized service center.</p>

If above solutions are not applicable, kindly refer to "Product Warranty Card" and contact service center.

## Troubleshooting (Continued)

### Expected sounds and feelings when using the massage chair.

**You will hear these specific sounds when using the product. These not defective indicators but a normal function of the chair.**

- When chair extends or retracts you will hear gears moving and clicking.
- A rubbing sound will be mildly heard when the massage heads are activated.
- When the massage heads are tapping you may hear a mild clicking sound.
- Friction sounds will be experienced as the rollers are activated.
- As the rollers move up and down the motor produce a sound.
- As the rollers are activated you will hear spinning of belts rotating.
- Motor sounds will be experienced.
- As the massage heads are squeezing, a mild squeaking sound will be heard.
- When sitting in the chair as the roller heads are tapping and rolling a mild squeaking sound may be produced from the joints.
- Common joints that may squeak would be from the side panels
- Friction sound between the massage wheels and the fabric.
- Motors will be heard from the pump when the airbags deflate.
- While the airbags are activated you will hear air valves alternating. When the legrest is moving, you will hear mild squeak and a motor operating.



**If the sound is loud, it is also possible that the product has failed.**

- In this case, have the product inspected and repaired by an authorized service center.

### **Warning**

- **Do not refit, disassemble or repair the product without permission.** Otherwise fires, abnormal movements or personal injuries may happen.

### **Warning**

- **In the case of any abnormality or fault, stop the product immediately and pull out the power plug to avoid fuming, fires and electric shocks.**

<Abnormality and fault example>

- The product fails to work after the power switch is turned to the ON position;
  - When the power cable is moved the chair will turn off and on.
  - In use, the product gives off a burning smell or an abnormal sound;
- The product upholstery is deformed or abnormally hot.

If any of these symptoms occur, have the product inspected and repaired by an authorized service center immediately.

# Specifications

<b>Product Name</b>		<b>4D Manhattan Duo Mech</b>
<b>Rated Voltage</b>		110 -120V 60Hz
<b>Current</b>		1.7A
<b>Working time</b>		15min
<b>Guide</b>		L Shape 52.4"
<b>Upper 4D Massage Rollers</b>	<b>Forward arc distance</b>	7 Levels Approx 4.96"
	<b>Strength</b>	5 levels
	<b>Speed</b>	5 levels
<b>Lower 3D Massage Rollers</b>	<b>Forward arc distance</b>	7 Levels Approx 4.96"
	<b>Strength</b>	5 levels
	<b>Speed</b>	5 levels
<b>Airbags</b>	<b>Intensity</b>	5 levels
<b>Angle Adjustment</b>	<b>Backrest</b>	Approx 128°- 155° (Ground Angle)
	<b>Footrest</b>	Approx 7°-65° (Wall Angle)
<b>Size</b>	<b>Upright</b>	63.0" x 31.5" x 47.6"
	<b>Reclined</b>	76.8" x 31.5" x 40.9"
<b>Extension of Footrest</b>		Approx 7.1"
<b>Dimensions of Packing (L*W*H)</b>		57.9" x 33.5" x 50.8"
<b>N.W.</b>		273.2 lbs
<b>G.W.</b>		329.6 lbs
<b>Weight of Chair</b>		Approx 273.2 lbs
<b>Usage Condition</b>		Environment temperature : "32°F ~95°F"
		Contrasting humidity : "20-80RH"
<b>Storage Condition</b>		Storage temperature : "23°F ~95°F"
		Storage humidity : "20-80RH"
<b>Maximum Weight of User</b>		260 lbs

# FCC Radiation Exposure Statement

---

This equipment complies with FCC radiation exposure limits set forth for an uncontrolled environment. In order to avoid the possibility of exceeding the FCC radio frequency exposure limits, Human proximity to the antenna shall not be less than 20cm (8 inches) during normal operation.

## FCC STATEMENT

1. This device complies with Part 15 of the FCC Rules. Operation is subject to the following two conditions:
  - (1) This device may not cause harmful interference, and
  - (2) This device must accept any interference received, including interference that may cause undesired operation.
2. Changes or modifications not expressly approved by the party responsible for compliance could void the user's authority to operate the equipment.

This equipment has been tested and found to comply with the limits for a Class B digital device, pursuant to part 15 of the FCC Rules. These limits are designed to provide reasonable protection against harmful interference in a residential installation. This equipment generates, uses and can radiate radio frequency energy and, if not installed and used in accordance with the instructions, may cause harmful interference to radio communications. However, there is no guarantee that interference will not occur in a particular installation. If this equipment does cause harmful interference to radio or television reception, which can be determined by turning the equipment off and on, the user is encouraged to try to correct the interference by one or more of the following measures:

- Reorient or relocate the receiving antenna.
- Increase the separation between the equipment and receiver.
- Connect the equipment into an outlet on a circuit different from that to which the receiver is connected.
- Consult the dealer or an experienced radio/ TV technician for help.

## Industry Canada Notice

---

This device complies with Industry Canada licence-exempt RSS standard(s).

1. Operation is subject to the following two conditions:

- (1) this device may not cause interference, and
- (2) this device must accept any interference, including interference that may cause undesired operation of the device.

2. Changes or modifications not expressly approved by the party responsible for compliance could void the user's authority to operate the equipment.

### Avis d'Industrie Canada

Le présent appareil est conforme aux CNR d'Industrie Canada applicables aux appareils radio exempts de licence.

1. L'exploitation est autorisée aux deux conditions suivantes :

- (1) l'appareil ne doit pas produire de brouillage, et
- (2) l'utilisateur de l'appareil doit accepter tout brouillage radioélectrique subi, même si le brouillage est susceptible d'en compromettre le fonctionnement.

2. Cet appareil numérique ne dépasse pas les Rèlements sur l'interférence radio par un appareil numérique de classe B stipulées dans les Règlement sur l'interférence radio d'industrie Canada.

