

AmaMedic

AM-R7 LE

INSTRUCTION MANUAL

Enjoy the space capsule Massage Chair

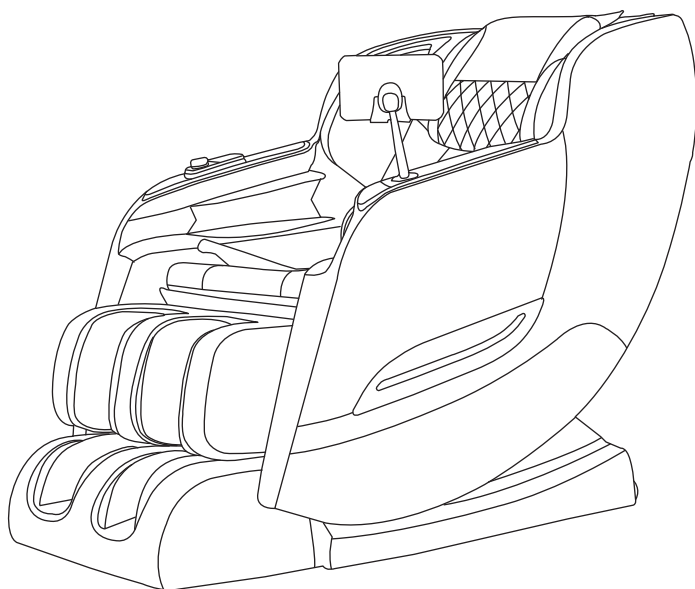

PLEASE BE SURE TO READ THIS MANUAL CAREFULLY TO LEARN THE OPERATIONS OF THIS PRODUCT. DO NOT DISPOSE OF THE MANUAL AND KEEP FOR FUTURE REFERENCE.

IMPORTANT SAFETY INSTRUCTIONS

Operating environment

- Do not use or store the massage chair in a damp environment such as a bathroom, sauna or spa to prevent mould, electric shock fire or mechanical failure.
- Do not use the massage chair outdoors.
- Do not use the massage chair under dusty, smeaery or anoxic conditions.
- Do not place the massage chair near a heater stove or under direct sunlight where the heat radiated may cause inner components to overheat and cause a fire.
- Ensure that the massage chair is standing on a flat and level ground.
- Ensure that there is an earthed connection for the massage chair to prevent electric shocks.
- Do not use the massage chair while smoking.

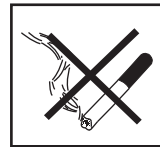
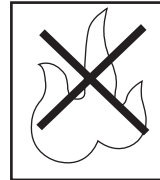









Please consult doctor before using chair if you have the following conditions:









- Suffering from a malignant tumour
- Serious heart disease
- Serious skin disease
- Serious boned hyperplasia
- Resting under doctor's supervision
- Bad back from accident or illness
- Need of peaceful surroundings
- Arthritis
- Implanted pacemaker
- Bowel ailments (eg, gastritis, enteritis, diarrhoea, hepatitis)
- Serious blood circulation problem
- Consciousness problem
- Hyper pyretic

⚠ WARNING

Children under 18 or physically or mentally-challenged persons are not allowed to operate the massage chair to prevent electric shock, injuries or mechanical malfunctions.

For safety reasons and to highlight the potential dangers of improper use of the product, the instructions below should be closely adhered to.

Non-professional technicians are not allowed to dismantle or repair the chair to avoid fire, electric shock or serious injuries.	
Do not wet the switch when cleaning so as to avoid an electric shock or short circuit.	
During storage, cleaning or maintenance, ensure that the power plug is disconnected from the socket. Do not detach the plug with wet hands. Make sure that power cord is detached when moving the chair.	
Do not place the chair on an unstable surface to prevent electric shock or chair overturning.	
Clean power plug periodically to prevent fire due to dust.	
Do not use the chair at unsafe places or for other purposes. This may cause product damage or accidents.	
Keep the power cord free of entanglement at all times and do not place heavy items on it.	
The chair has a heated surface. Ensure that persons who are insensitive to heat to be careful when using the chair.	

Do not modify the structure or change components by unauthorised persons. It may cause an electric chock, short circuit or fire.	
Do not store the chair near fire or flammable substances. It may cause product damage and defects.	
Should any problem or abnormality (such as burning smell) occur, stop using the chair immediately and detach the power plug from the socket. Operating under such circumstances may cause a fire or electric shock. Contact your supplier or authorised agent for repairs and advice.	
Only use the rated voltage specified for the chair.	
Stop using the chair immediately if the power cord or power plug is damaged or loose.	
Keep children away from the chair when it is in operation to avoid any accident or injury.	
Do not place the chair under direct sunlight at all times.	
If the power cord is damaged, it must be replaced by the manufacturer, supplier or authorised agent.	

 **WARNING**

Supervision and guidance are necessary when children, physically or mentally-challenged persons, and persons inexperienced or lack of knowledge with the use of massage chairs intend to use the massage chair. Unless there is someone who is able to be responsible for their safety, the massage chair should be unavailable to them. Please ensure that children do not play with the chair. The chair has a heated function and must be used with caution with anyone who is insensitive to heat.

RF exposure statement

This equipment complies with the FCC radiation exposure limits set forth for an uncontrolled environment. This transmitter must not be co-located or operating in conjunction with any other antenna or transmitter.

FCC Warning

This device complies with Part 15 of the FCC Rules. Operation is subject to the following two conditions:

(1) This device may not cause harmful interference, and (2) this device must accept any interference received, including interference that may cause undesired operation.

NOTE 1: This equipment has been tested and found to comply with the limits for a Class B digital device, pursuant to part 15 of the FCC Rules. These limits are designed to provide reasonable protection against harmful interference in a residential installation. This equipment generates uses and can radiate radio frequency energy and, if not installed and used in accordance with the instructions, may cause harmful interference to radio communications. However, there is no guarantee that interference will not occur in a particular installation. If this equipment does cause harmful interference to radio or television reception, which can be determined by turning the equipment off and on, the user is encouraged to try to correct the interference by one or more of the following measures:

- Reorient or relocate the receiving antenna.
- Increase the separation between the equipment and receiver.
- Connect the equipment into an outlet on a circuit different from that to which the receiver is connected.
- Consult the dealer or an experienced radio/TV technician for help.

NOTE 2: Any changes or modifications to this unit not expressly approved by the party responsible for compliance could void the user's authority to operate the equipment.

SPECIFICATIONS

Product name	Massage Chair
Model	AmaMedic AM-R7 LE
Power supply	120V~ 60Hz
Current	1.2A
Rated working time	15mins

WARNING

Use only the rated supply of 120V~ to avoid damage to electrical and electronic components of the chair.

MASSAGE CHAIR PARTS

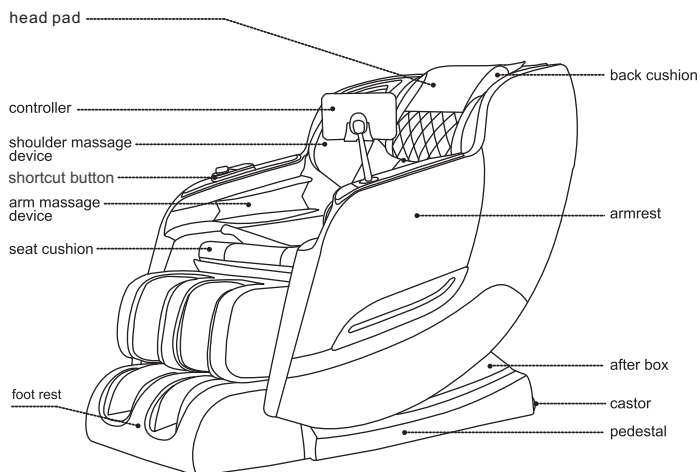

REMOTE CONTROL FUNCTIONS

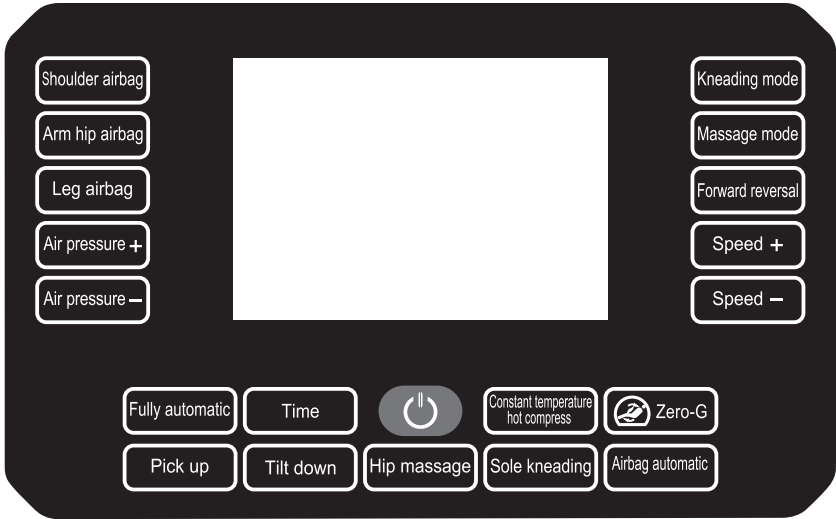

Controller

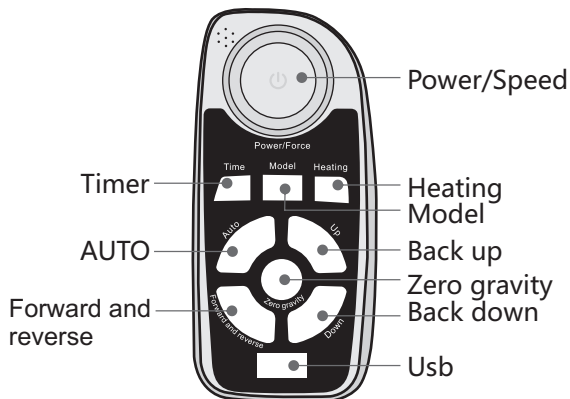

Shortcut Button

OPERATIONS GUIDE

1. Turn on the power and turn the switch to the “I” position.

- ▶ Insert the power plug into power socket, and push the power switch to “ I ” position. The chair is in resetting condition, remote power key indicator will flash quickly. After reset, the chair goes to standby mode.

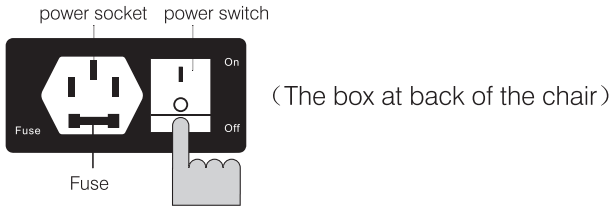

Warning: Do not insert or pull out the power plug with wet hands, otherwise an electric shock would happen.

2. Sit on massage chair and press the “ON” button to start.

Remote Control Usage Guide



•On/Off

Press this button to start/stop the massage system.

Fully automatic

•Full automatic massage

Press this button to switch an auto program each time, there are 5 auto programs for choice.

Kneading mode

•Kneading massage mode

Press this button to start/stop kneading massage.

Massage mode

•Massage mode

Press this button to start/stop massage mode.

Forward reversal

•Forward reversal

Press this button to choice forward or reversal massage.

Hip massage

•Hip massage

Press this button to start/stop hip massage.

Sole kneading

◦ **Sole kneading massage**

Press this button to start/stop sole kneading massage.

Airbag automatic

◦ **Airbag automatic massage**

Press this button to start/stop automatic airbag massage.

Shoulder airbag

◦ **Shoulder Airbag Massage**

Press this button to start/stop shoulder airbag massage.

Arm hip airbag

◦ **Arm airbag massage**

Press this button to start/stop arm airbag massage.

Leg airbag

◦ **Leg airbag massage**

Press this button to start/stop leg airbag massage.

Constant temperature
hot compress

◦ **Heating Function**

Press this button to start/stop waist heating function.

Pick up

◦ **Back Up**

Press this button, the backrest will be moved up to the original position, release this button, it will stop.

Tilt down



◦ **Back Down**

Press this button, the backrest will be moved down to the lowest position, release this button, it will stop.

Speed +

◦ **Massage speed**



Speed -

Under manual mode, Press “  ” button to increase the massage speed, Press “  ” button to decrease the massage speed.
3 levels of intensity for choice.

Air pressure +

◦ **Airbag Intensity**

Air pressure -

Open airbag function, Press “  ” button to increase the airbag intensity, Press “  ” button to decrease the airbag intensity.
3 levels of intensity for choice.

Time

◦ **Timing**

Press this button to set the timing of 5-10-15-20-25-30 minute.

 Zero-G

◦ **Zero Gravity**

Press this button, the chair will go to zero-gravity position.
Press it again, the chair will go back to original position.

Mode Switching

Auto Mode: In auto mode, there are 5 auto programs for choice.

Manual Mode: In manual mode, choose any of manual function on the remote control to have a specific massage.

Bluetooth Connection

Bluetooth function is turned on when the machine turned on.

Turn on your mobile Bluetooth function and search the massage Bluetooth: “AmaMedicXXXXXX” and connect to play the music.

3 Restore massage chair.

Press “  ” button after using.

Warning

Do not stand in the leg cushion before it restores to original position to prevent any damage to leg cushion.

 **Warning:** Supervision and guidance is mandatory for those disabled mentally and physically. Please advise with your doctor before using the chair if you have ANY medical conditions. Children under 18 should not use the chair and consult with a doctor for approval if attempted. Do not operate the chair if there are any children or pets near by. Serious injuries may occur if these instructions are not followed.

SAFETY INSTRUCTIONS

- Should any abnormality or problem occurs with the chair, switch off the chair and detach the power cable from the power socket.
- When the power cord is damage, it must be replaced by one from the manufacturer or agent.
- Do not attempt to dismantle, modify or change components by unauthorised persons to avoid any electric shock, fire or injury.

CARE AND MAINTENANCE

Storage

- Do not dismantle the back of the chair. Electric shocks may occur when touching inner components of the chair.
- Do not dismantle the chair by unauthorised personnel to prevent electric shocks, fire and injury.
- Ensure that the chair is switch off and the power plug is detached from the socket when cleaning the chair to avoid any electric shock or hazard.
- Keep the massage chair clean and free of dust. Do not place the chair in a damp environment.
- If the chair is not in use for long periods, please cover it with a cloth to protect it from dust.
- Do not place the chair under direct sunlight.

Maintenance

- Use a neutral detergent only to clean the back cushion, head cushion and leg cushion. Let it air dry.
- Use a cloth and detergent to clean the plastic parts, pipe and leather material of the massage chair.
- Do not use organic solvents such as gasoline, amyl acetate or benzene to clean to prevent leather colour fading, ageing or damage.
- Do not spray pesticides on the chair to avoid electric shocks or fire.
- Only clean with a dry cloth to prevent mechanical failure.

Remote controller care

- Do not place the remote controller or massage chair near to a heater or fire source.
- Remove dust on remote controller with a soft cloth or small banister brush.
- Do not use volatile solvents like benzene, gasoline or amyl acetate to clean the remote controller.

TROUBLESHOOTING

Check the massage chair periodically when it is in frequent use for any defects or damage.

If the massage chair has not been used for some time, please ensure that all components are in working order before using it.

PROBLEM	SOLUTION
Failure to start and indicator light is off	<ol style="list-style-type: none">1. Check that plug is well connected.2. Check that switch on chair is set to “1” position.
Sounds during operation	<p>These are normal sounds during operations</p> <ol style="list-style-type: none">1. Sounds from kneading or knocking.2. Sounds from speed adjustment.3. Sounds from box in massage mode.4. Sounds from vibration in back massage.5. Sounds from air input and output.6. Sounds from airbag inflating and venting.7. Sounds from leg adjustments.8. Sounds from motor when massage chair is loaded.