

# LYS4000

Luxury Plug & Play  
Owner's Manual - 60Hz



**Electrical:** 120V/15A

**Weight:** 450 lbs (Dry), 2050 lbs (Filled)

**Water Capacity:** 190 gal / 730 L

**Jet Count:** 20

**Seat Count:** 4

**Size:** 84" x 60" x 29"

**Pump(s):** 1 x 2 HP, 2 Speed

**Heater:** 1.5 kW

**Filter(s):** 1 x 50sq ft Glacier  
Antimicrobial Filter (KA-10082)

# SAFETY INFORMATION

## NORTH AMERICA (60Hz)

### IMPORTANT SAFETY INSTRUCTIONS

When installing and using this electrical equipment be sure to follow these basic safety precautions:

1. **WARNING:** To reduce the risk of injury, do not permit children to use this product unless they are closely supervised at all times.
2. **DANGER:** Risk of accidental drowning. Extreme caution must be exercised to prevent unauthorised access by children. To avoid accidents, ensure that children cannot use this spa unless they are supervised at all times.
3. **DANGER:** Risk of injury. The suction fittings in this spa are sized to match specific water flow created by the pump. Should the need arise to replace the suction fitting or the pump, ensure that the flow rates are compatible. Never operate the spa if suction fittings are broken or missing. Never replace a suction fitting with one rated less than the flow rate marked on the original suction fitting.
4. **DANGER:** Risk of Electrical Shock. Install at least 5ft (1.5m) from all metal surfaces. As an alternative, spa may be installed within 5ft (1.5m) of metal surfaces if each metal surface is permanently connected (bonded) by a minimum ground wire.
5. **DANGER:** Risk of Electrical Shock. Do not permit any electrical appliance such as a light, telephone, radio, television, etc. within 5ft (1.5m) of a spa unless such appliances are installed and built-in by the manufacturer.
6. **ELECTRICAL SUPPLY:** The electrical supply for this product must include a suitably rated switch or circuit breaker to open all ungrounded supply conductors to comply with the national electrical standards. This disconnect must be readily accessible and visible to the spa occupant but installed at least 5ft (1.5m) from the spa water.
7. **WARNING:** To reduce the risk of injury:
  - a) The water in the spa should never exceed 40°C (104°F). Water temperature between 38°C (100°F) and 40°C (104°F) is considered safe for a healthy adult. Lower water temperatures are recommended for young children and when the spa use exceeds 10 minutes.
  - b) Since excessive water temperatures have a high potential for causing fetal damage during early months of pregnancy, pregnant women should limit spa water temperatures to 38°C (100°F)
  - c) Before entering a spa, the user should measure the water temperature with an accurate thermometer since the tolerance of water temperature regulating devices varies.
  - d) The use of alcohol, drugs, or medication before or during spa use may lead to unconsciousness with the possibility of drowning.
  - e) Obese persons and persons with a history of heart disease, low or high blood pressure, circulatory system problems, or diabetes should consult a physician before using a spa.
  - f) Persons using medication should consult a physician before using a spa since some medication may induce drowsiness while other medication may affect heart rate, blood pressure, and circulation.
  - g) This spa enables the user to determine the temperature and duration for which they are immersed in the spa. Before using a cold spa, you should always ask a qualified professional if use of this spa is safe and appropriate for you.
  - h) For spa/hot tubs installed indoors, care should be taken to ensure adequate ventilation for the indoor space, to avoid undesired build of humidity due to spa water. For additional information on ventilation/humidity guidelines see the ASHRAE Handbook, HVAC Applications, I-P Edition, 4.5, 4.6, and 4.7.) Spas that include gas-burning heating components, shall be installed in accordance with NFPA 54 or other local codes.
8. The causes, symptoms, and effects of hypothermia may be described as follows: Hypothermia occurs when the internal temperature of the body reaches a level several degrees below the normal body temperature of 98.6 °F (37 °C). The symptoms of hypothermia include, but not limited to, shivering, slurred speech or mumbling, slow, shallow breathing, weak pulse, clumsiness, drowsiness, confusion, unconsciousness, and bright red, cold skin (in infants). The effects of hypothermia include failure of the nervous system, respiratory system and heart; failure to recognize the need to exit spa or cold tub; unawareness of impending hazard; fetal damage in pregnant women; physical inability to exit the spa or cold tub; and unconsciousness resulting in the danger of drowning.  
**WARNING** – The use of alcohol, drugs, or medication can greatly increase the risk of fatal hypothermia.
9. This product shall be installed in accordance with local codes.
- a) The spa cover should be in place and properly latched when spa is not in use to protect against unauthorized access as per local codes.

- b) Proper water chemistry is necessary to maintain the water and prevent possible damage to spa components and shall be tested and treated in accordance with local codes.
10. **AUDIO/VIDEO EQUIPMENT WARNINGS (Optional equipment based on model)**  
**CAUTION:** Risk of Electrical Shock. Do not leave compartment door open.
11. **CAUTION:** Risk of Electrical Shock. Replace components only with identical components.
12. **WARNING:** Prevent Electrocutation. Do not connect any auxiliary components (for example cable, additional speakers, headphones, additional audio/video components, etc.) to system.
13. **CAUTION:** Risk of Electrical Shock. Do not service this product yourself as opening or removing audio covers may expose you to dangerous voltage or other risk of injury. Refer all servicing to qualified service personnel.
14. **CAUTION:** Risk of Electrical Shock. When the power supply connections or power supply cord(s) are damaged; if water is entering the audio / video compartment or any electrical equipment compartment area; if the protective shields or barriers are showing signs of deterioration; or if there are signs of other potential damage to the unit, turn off the unit and refer the servicing to a qualified service personnel.
15. This unit should be subject to periodic routine maintenance (for example, once 3 months) to make sure that the unit is operating properly.
16. **CAUTION:** Do not operate audio video controls while inside the spa.
17. Installation of the spa for other than a residential dwelling will result in voiding the manufacturer's warranty.
18. Do not bring any object into the spa that could damage the spa shell.
19. Never insert any object into any opening.
20. **WARNING:** Do not sit on the spa cover or place objects on it.
21. Remove any water or debris that may collect on the spa cover.
22. **WARNING:** Do not use the spa immediately after strenuous exercise.
23. If you feel pain or dizziness at any time while using the spa, discontinue use and contact a physician.
24. **WARNING:** To reduce risk of injury it is especially important that persons with pre-existing health conditions or problems such as obesity, heart disease, high or low blood pressure, circulatory problems, pregnancy or diabetes consult their doctor before using the spa.
25. **WARNING:** Observe reasonable time limits when using the spa. Long exposures at high temperatures can cause high body temperatures. Symptoms may include dizziness, nausea, fainting, drowsiness, and reduced awareness. These effects could possibly result in drowning.
26. **WARNING:** The spa jets produce a stream of water with relatively high pressure. Prolonged exposure of localized area of the body may cause bruises to the skin.
27. **IMPORTANT:** The included warning sign must be posted where all users of the spa can see and read it.
28. **WARNING:** To avoid risk of drowning. The spa cover should be in place and properly latched when spa is not in use.
29. **IMPORTANT:** Read and understand the warnings on the spa cover.
30. Proper water chemistry is necessary to maintain the water and prevent possible damage to spa components.

 <b>WARNING</b>
<b>REDUCE THE RISK OF ELECTROCUTION</b> 1. Never place an electric appliance within 5ft (1.5m) of spa.
<b>REDUCE THE RISK OF CHILDREN DROWNING</b> 1. Supervise children at all times. 2. Attach and lock down spa cover after
<b>REDUCE THE RISK OF OVERHEATING</b> 1. Check with a doctor before use if pregnant, diabetic, in poor health, or under medical care. 2. Exit immediately if uncomfortable, dizzy, or sleepy. Spa heat can cause hyperthermia and unconsciousness. 3. Spa heat in conjunction with alcohol, drugs, or medication can cause unconsciousness.
<b>WHEN PREGNANT</b> Soaking in hot water for long periods can lead to pregnancy concerns. Measure water temperature before entering. 1. Do not enter spa if water is hotter than 100°F (38°C). 2. Do not stay in spa for longer than 10 minutes.



# QUICK START GUIDE

## Register Warranty



Make sure to register your warranty at [libertyspas.com/warranty](http://libertyspas.com/warranty)

## Electrical

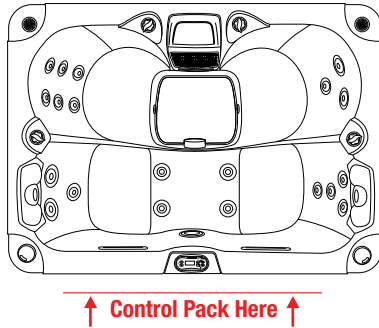

↑ Control Pack Here ↑

Your spa comes ready to be plugged in as 120V

**Note:** If you would like to install your spa as 240V, please work with a licensed electrician to complete the work needed prior to filling your spa

## Fill Your Hot Tub

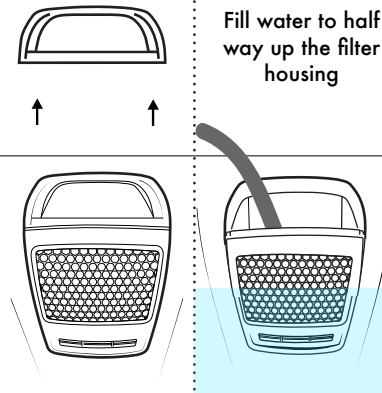

Fill water to half way up the filter housing

Remove filter cover and insert hose in opening to fill the spa through the filter housing

## Insert Filters

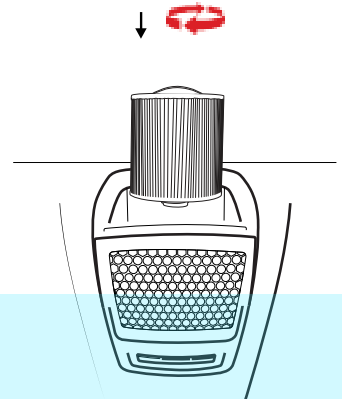

Once the hot tub is filled, install your new Glacier Antimicrobial Filter Set. Make sure not to over tighten

**Note:** Spa is filled when water is touching the LED perimeter lighting

## Power On

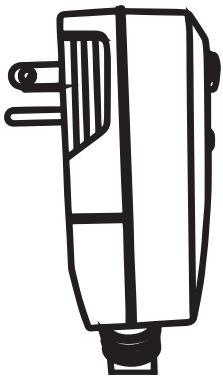

Plug the GFCI into a dedicated, 15 amp outlet and follow the start up instructions on page 10 of this manual

**Note:** You must allow the spa to run through its startup cycle before adjusting any pump or heater settings (5 to 10 minutes)

## Add Chemicals



SCAN below to try our Spa Water Test App



Follow our Spa Chemical Startup Guide instructions to balance your water

## Wait for Water to Heat

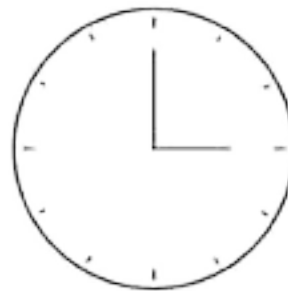

The water will take 24-48 hours for 120V to reach full temperature

## Enjoy



Sit back and relax in your brand new spa!



FOR MORE HELP GUIDES VISIT US AT:  
[libertyspas.com/support](http://libertyspas.com/support)  
1-844-879-7727

# INSTALLATION

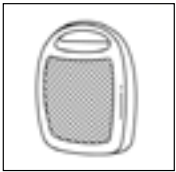

## WINTER INSTALL

Do NOT proceed with installing your hot tub in freezing temperatures! In colder temperatures please make sure to place a space heater inside the cabinet immediately after delivery for 24 to 48 hours before installation to prevent startup issues. Please ensure that the space heater is positioned to not directly face the spa's pipes and set to the lowest heat and fan setting.



## LICENSED ELECTRICIAN

A licensed electrician can install the wiring by drilling a hole into any panel and terminating the connection at the control pack. This step is not required for a 120V Plug & Play spa.



## PROPER SPA BASE

All hot tubs must be placed on a proper base that is reinforced for the weight of the hot tub, water and people who may be within the hot tub at any given time. This base must be flat and come in contact with the entire base of the spa. We recommend a base that can support at least 150 pounds per square foot such as a 4-6 inches poured concrete pad.

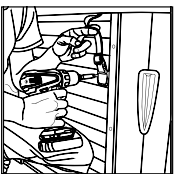

## ATTACH SPA COVER

Lay cover onto hot tub, pulling the cover skirt down around the perimeter of the spa. Pull down the locking, adjustable straps and secure to cabinet panels with the included mounting hardware. Always lock your cover when the spa is unattended. Do NOT walk or sit on spa cover.

## GFCI TROUBLESHOOTING

Keep in mind that the majority of 240V GFCI tripping problems can attribute to incorrect wiring. GFCI troubleshooting usually finds the problem

REFER TO DIAGRAM ON NEXT PAGE

### IF CORRECT WIRING IS VERIFIED

- **IMPORTANT:** All electrical installation work must be performed by a qualified electrician and must conform to local codes
- Check to see if the proper sized GFCI is installed.
- Be sure the GFCI is rated for more amperage than the system will draw.
- For a 240V system, the GFCI must include a load neutral out.
- **NOTE: If the white load neutral wire is routed from the GFCI neutral bar directly to TB1 in the system box, then the GFCI will trip when a 120V device is activated. This is the most common reason if your hot tub is tripping immediately.**
- If the wiring is correct and the GFCI will not reset, then unplug the heater and try to reset the GFCI.
- If the GFCI trips again, then unplug the pump and reset the GFCI. If the GFCI continues to trip, then do the same procedure for the ozone generator.
- If the GFCI stops tripping after you unplugged one of the spa's components, turn off the power to the spa then plug in each component except the one that tripped the GFCI.
- Power up the system. If the GFCI no longer trips, then you have correctly identified the problem.
- Repair or replace the component as instructed by the spa manufacturer.
- If everything looks to be in perfect working order, then the GFCI may be defective.

**WARNING: THE OWNER SHOULD TEST AND RESET THE GFCI ON A REGULAR BASIS TO VERIFY ITS FUNCTION**



FOR MORE HELP GUIDES VISIT US AT:  
[libertyspas.com/support](http://libertyspas.com/support)  
1-844-879-7727

# 240V GFCI Electrical Installation

House Breaker Box

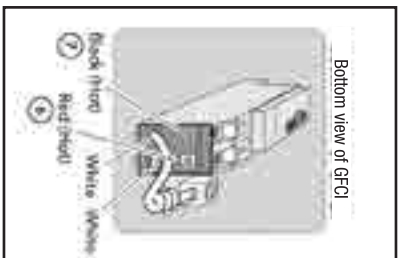
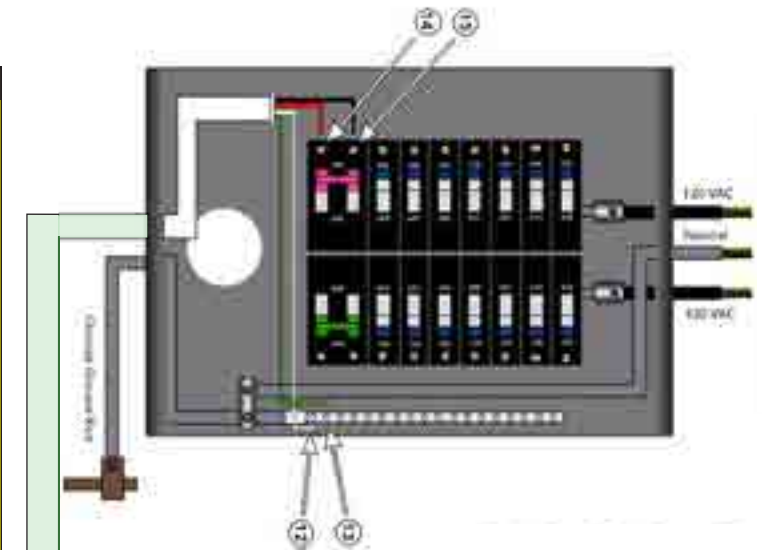

GFCI Breaker Box

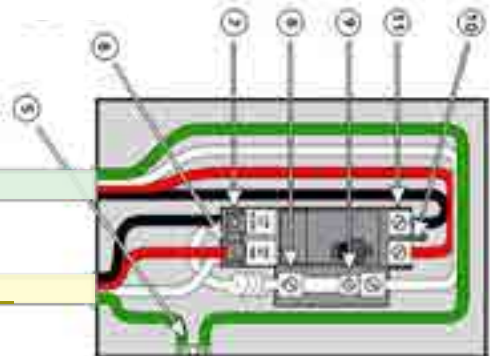

Correct Voltage	When Probes Are Placed Across
0v	[3 - 4] [5 - 8] [5 - 9] [12 - 13]
108V - 132V	[1 - 3] [5 - 6] [5 - 10] [12 - 14] [13 - 14] [2 - 3] [5 - 7] [5 - 11] [12 - 15] [13 - 15]
216V - 264V	[1 - 2] [6 - 7] [10 - 11] [14 - 15]

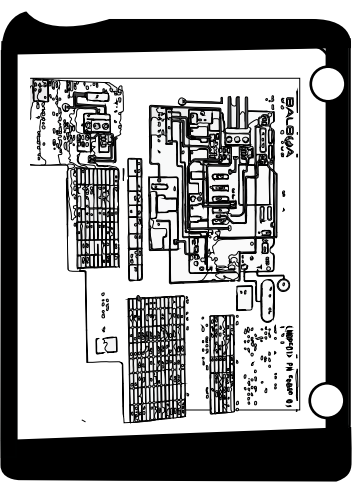
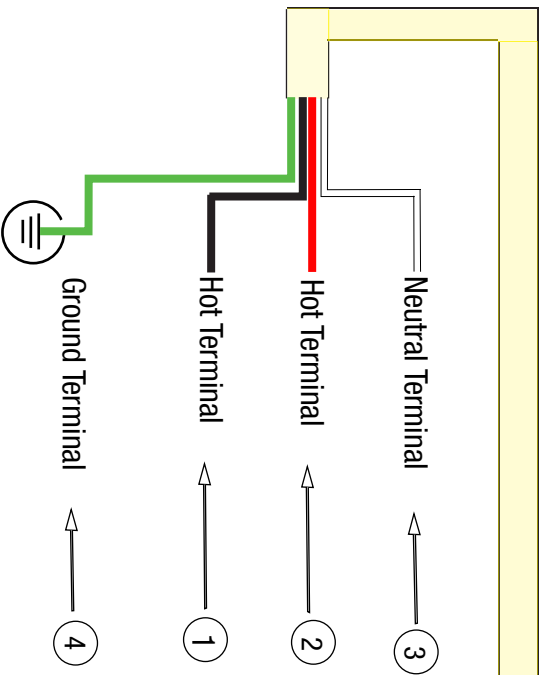

Please refer to wiring diagram on the back side of the spa pack cover for correct terminal installation

# FEATURE FUNCTIONS

## WHAT DOES THIS DO?

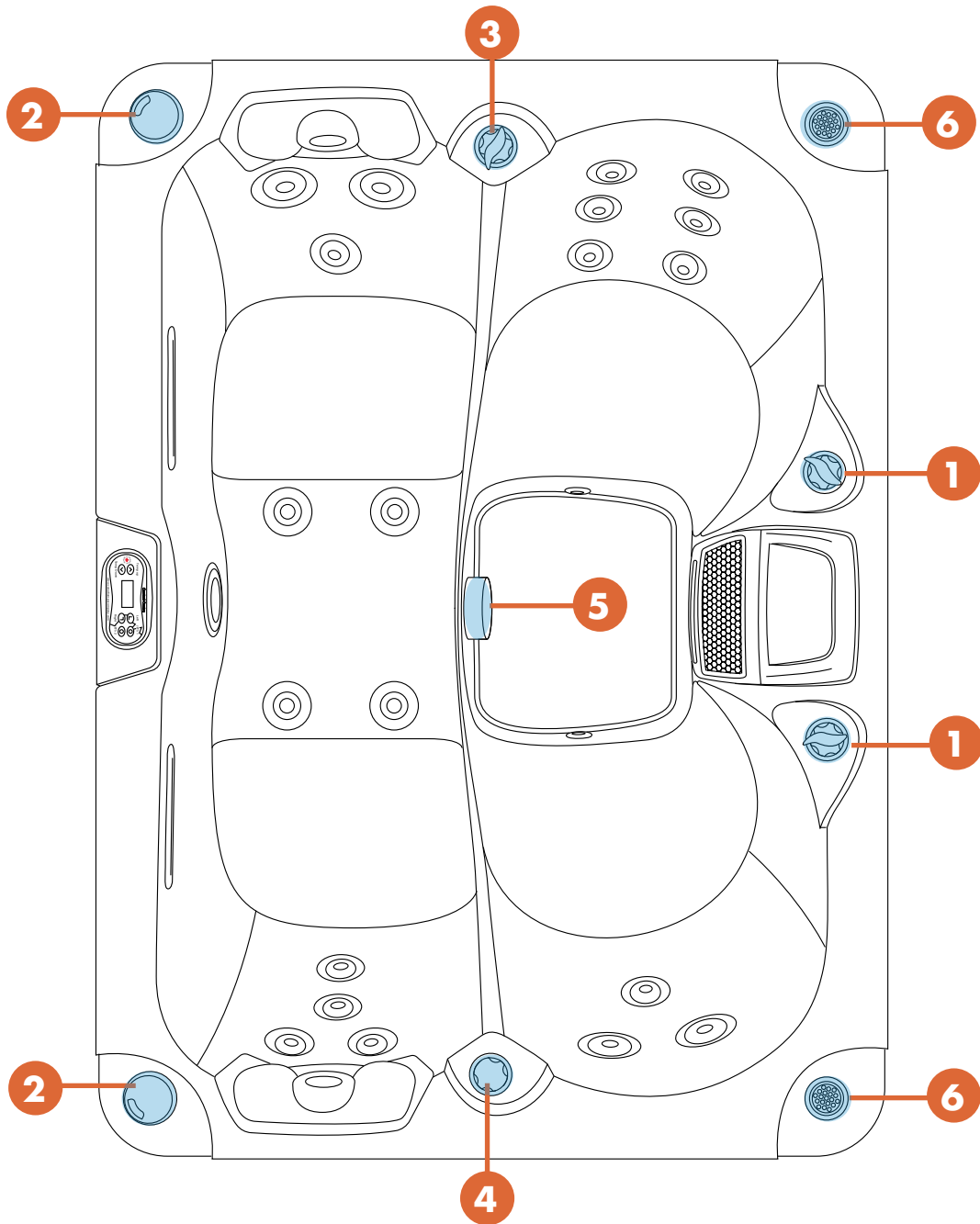

**1** Air Control

**2** Speaker

**3** Waterfall Control

**4** Aromatherapy

**5** Suction Intake

**6** LED Cup Holder

## WATERFALL CONTROL



The waterfall control valve controls the amount of water flowing out through the waterfalls.

## AROMATHERAPY



Place aromatherapy beads inside the canister to mix in with the air valves to release scented bubbles throughout the tub.

**Note:** the canister should be filled halfway.

## JETS



Our jets offer **massage or directional styles!** The directional style can target specific muscles for a precise massage where the massage style jet offers a circular and gentle massage. All jets are **interchangeable and adjustable!** Swap them around and turn them on and off to customize your spa to your satisfaction!

## AIR CONTROL VALVE



Open and close this valve to inject air bubbles into the jet stream. The warm air from inside the cabinet is mixed with the water to help maximize the hydrotherapy experience!

**Note:** It is recommended that Air Control Valve(s) are left in open position when the spa is not in use in **SUMMER** months.

It is recommended that Air Control Valve(s) are left in closed position when the spa is not in use in **WINTER** months.

## SUCTION INTAKE



This suction intake brings in water from the bottom of the tub for maximum efficiency. Please make sure these suctions are always clear and cleaned whenever the spa is drained!



FOR MORE HELP GUIDES VISIT US AT:  
[libertyspas.com/support](http://libertyspas.com/support)  
1-844-879-7727



# AMERICAN COMPONENTS YOU CAN RELY ON

Liberty Spas uses American components to ensure  
*quality, reliability, and longevity* of  
your spa – giving you the ultimate peace of mind.



# WE HAVE IT ALL

EXTEND YOUR SPA'S LONGEVITY

## GLACIER AO<sub>3</sub>P FILTRATION SYSTEM



Free of pollution, glaciers contain the world's most pristine water.

Our Glacier AO<sub>3</sub>P system sterilizes up to 99.9% of bacteria in your hot tub, reducing chemical usage by up to 80% and leaving your water crystal clear!

Purchase 18W UV Bulb separately. Available on our online store.



### LIBERTY SPAS ADVANCED OXIDATION PROCESS



Ozone Generator



UV-C Germicidal Light



Glacier Filtration



CSC Glacier AO3P

## SPA ACCESSORIES



Glacier Antimicrobial  
50 sq ft Filter



Cover Lifters



Water Care

# EQUIPMENT LOCATIONS

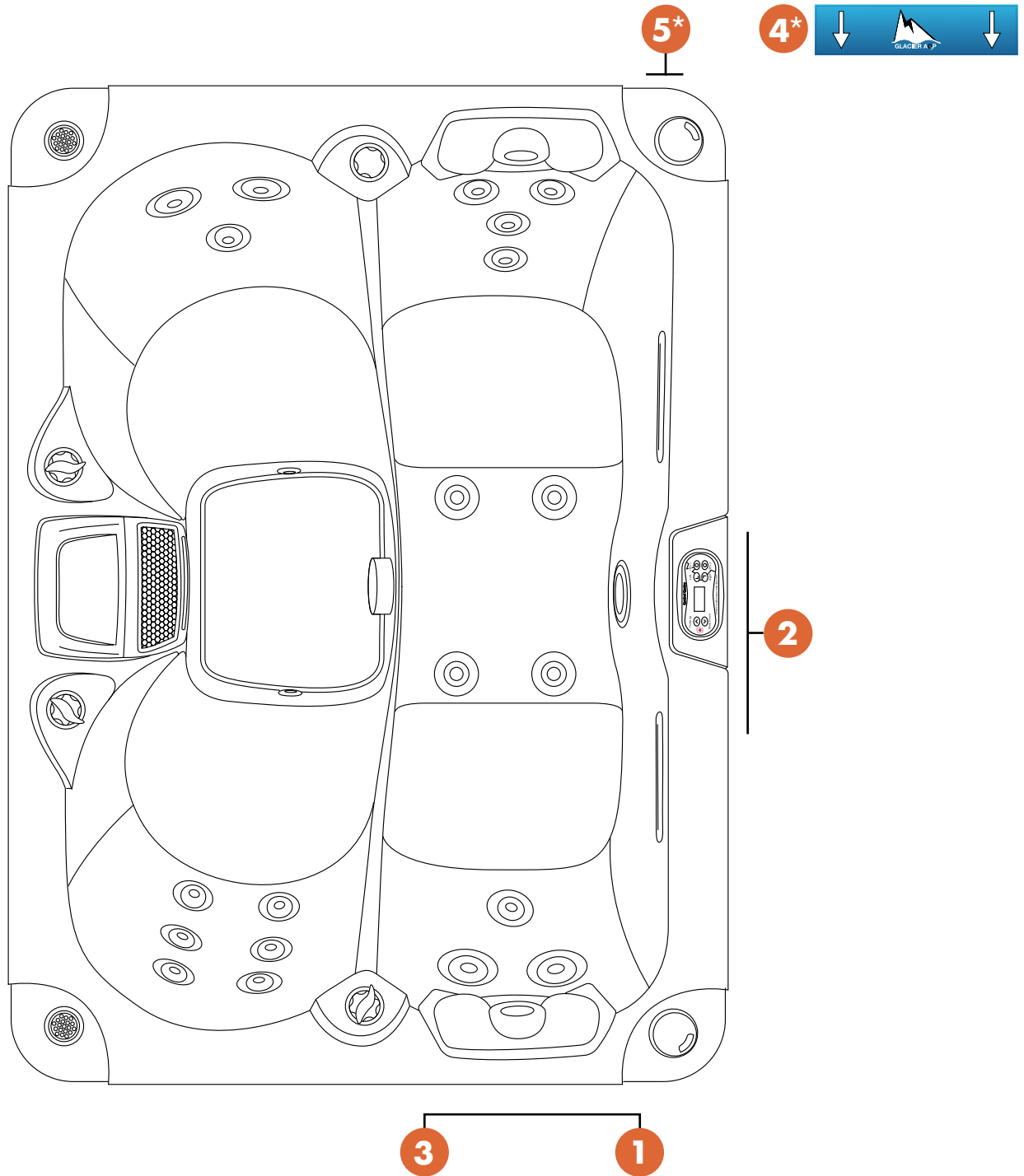

**1** Pump(s)

**2** Control Pack & Heater

**3** Drain

**4** Glacier AO<sub>3</sub>P\*  
(Locations may vary, refer to the AO<sub>3</sub>P Sticker on your spa)

**5** Electrical\*  
(Designated electrical panel)

## PUMPS



With up to 400% more hydro massage configurations, Liberty Spas' TurboStream multi-speed pumps give you endless combinations of jet speeds and power. From relaxation to aquatic exercise to marathon training, our pumps can really do it all.

## GLACIER AO<sub>3</sub>P



Free of pollution, glaciers contain the world's most pristine water. Our Glacier AO<sub>3</sub>P system sterilizes up to 99.9% of bacteria in your hot tub, reducing chemical usage by up to 80% and leaving your water crystal clear!

**Note:** UV bulb must be purchased separately and installed in order to take advantage of the advanced oxidization process.

## CONTROL PACK & HEATER



Our control pack software design incorporates patented technology using a microprocessor to intelligently monitor the hot tub water temperature and detect a runaway pump or stuck relays.

## ELECTRICAL \*



Plug and Play models have designated electrical panels so please keep this in mind when placing your tub in its location. All 240V hot tubs allow you to choose which panel you would like to drill a hole into for your wiring to pass through.

## DRAIN



Twist and pull out the drain valve to access the built-in drain and attach your garden hose for better convenience. We recommend that you change your water seasonally.



FOR MORE HELP GUIDES VISIT US AT:  
[libertyspas.com/support](http://libertyspas.com/support)  
1-844-879-7727

# CONTROL CENTER GUIDE

## YOUR CONTROL CENTER

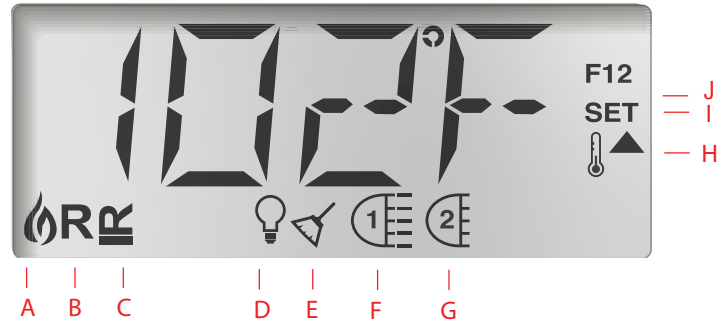

\*Only on multi-pump spas

- A - Heat:** Indicates that the heater is on
- B - Ready Mode:** Set temperature will be maintained at all times (Recommended for Winter months)
- C - Rest Mode:** Heater will only run during filtration cycles (Recommended for Summer months)
- D - Light:** Multiple colour choices for your custom experience
- E - Cleanup Cycle:** Pump will run 30 min after spa use to filter and clean spa for 30 min
- F - Jets 1:** Pump 1 is on **Note: longer lines for high speed**
- G - Jets 2:** Pump 2 is on **Note: short lines for low speed**
- H - Temperature Range:** Temperature can be set between 80°F and 104°F
- I - SET:** Appears when changing settings
- J - Filter Cycle:** Indicates spa is running the filtration cycle

## START UP SEQUENCE

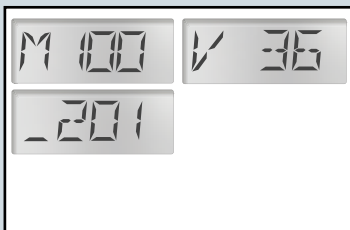

When power is applied to the spa, the first messages will be the version number of the system



Make sure the voltage shown on your screen matches the electrical voltage of the hot tub (120V **OR** 240V)

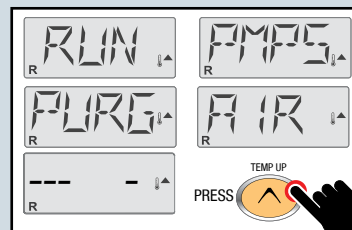

Spa will attempt to "Prime" itself, press "TEMP UP" to bypass

**Note:** Do NOT press "pumps" button at this time.

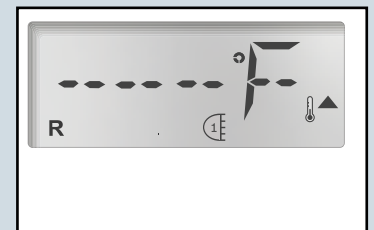

Pump 1 will then run on low speed to read current temperature. It will then start to heat up to the set temperature.

**Note:** TOO COLD message may occur if the initial water is too cold. Pump will continue to run until temperature reaches 45°F at which point the heater will turn on

## SETTING THE TEMPERATURE



Pressing the "TEMP UP" button or the "TEMP DOWN" button will cause the current set temperature to flash



Press the "TEMP UP" or "TEMP DOWN" button to set desired temperature while the numbers are flashing



When the flashing stops, the temperature is set and will show the current temperature of the water



Once temp is set, heat icon will appear in the bottom left of the screen, flashing. When this icon stops flashing, the heater is on

**Note:** Jets 1 low speed will continue to run until the set temp is reached

# CONTROL CENTER GUIDE

## TURN ON THE LED LIGHTS



Press "LIGHT" button to activate lights



Press "LIGHT" button repeatedly until desired light setting is active

## TURN ON THE PUMPS

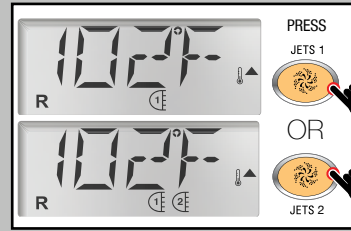

Press "JETS 1" button for pump 1 low speed to turn on. Press "JETS 2" button to activate pump 2 (if available)

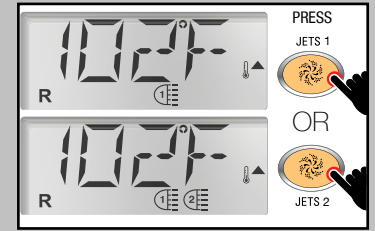

Press "JETS 1" button or "JETS 2" button a second time for high speed (if available)

## CHANGE THE SPA HEATING MODE (READY/REST)



Press the "MENU" button until your screen displays MODE



Press the "TEMP UP" or "TEMP DOWN" button to select Ready R or Rest Mode REST then press "MENU" again to complete action

**Note: It is recommended to leave the spa in READY mode**

### Ready Mode

Spa will automatically run the low speed of the pump every 30 minutes to check the current temperature and start heating if required until the set temperature has been reached. This mode is highly recommended during winter time to avoid any freezing than can result in damages to the spa.

### Rest Mode

Spa will only heat during the Filtration cycles. If they are set for 2 hours, then the pump will only run during that period of time unless you manually activate the jets.

## SET THE FILTER DURATION (IN HOURS)

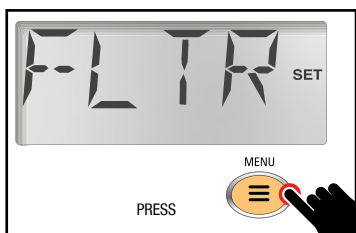

Press "MENU" button until your screen flashes FLTR

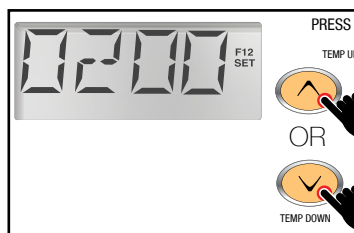

Press "TEMP UP" or "TEMP DOWN" button to set the number of hours you would like your filtration cycle to run every 12 hours. Press "MENU" again to complete action.

**Note: 2:00 means the spa would filter for a total of 4 hours per day (recommended)**

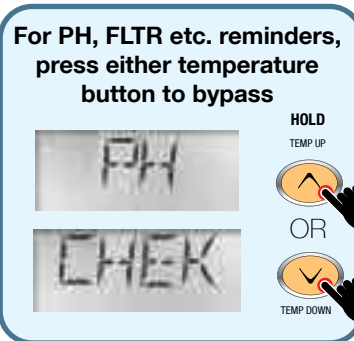

For PH, FLTR etc. reminders, press either temperature button to bypass

**Note: this is only a reminder notice. The spa does not monitor chemicals or filters**

## FLIP/INVERT THE DISPLAY

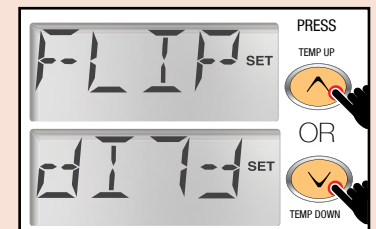

Press "MENU" button until your screen flashes FLIP. Press "TEMP UP" or "TEMP DOWN" button to set which orientation you would like for the screen to display. Press "MENU" again to complete action

# SPA CHEMICAL STARTUP GUIDE

## AVAILABLE CHEMICALS



Chlorine Granules, Alkalinity Booster, pH Up, pH Down, Spa Shock, Spa Clear, Foam Free, Stain & Scale Control, Spa Flush, Test Strips

**Note:** Chemicals should be stored in a cool, dry place.

## USING CHEMICALS

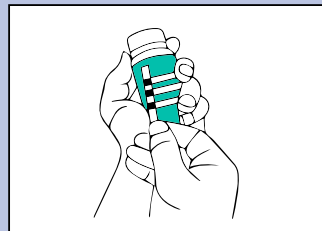

**Start with testing your water**  
then balance your chemicals in the following order:  
*Alkalinity, pH, Chlorine*

### Step 1

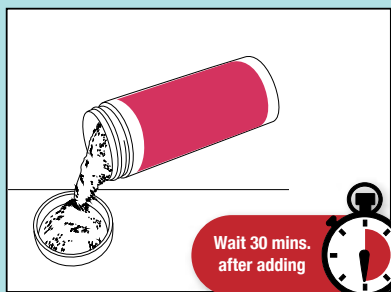

Wait 30 mins.  
after adding

#### Alkalinity Booster

Adjust alkalinity level to 80 - 150 ppm  
(use pH Down to reduce)  
(see bottle for directions)

### Step 2

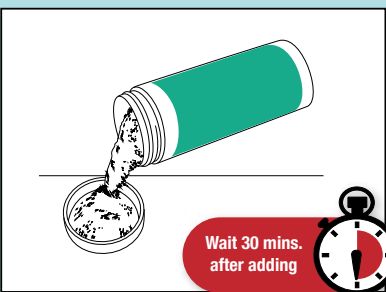

Wait 30 mins.  
after adding

#### pH Up / pH Down

Adjust pH level to 7.2 - 7.6  
(see bottle for directions)

### Step 3

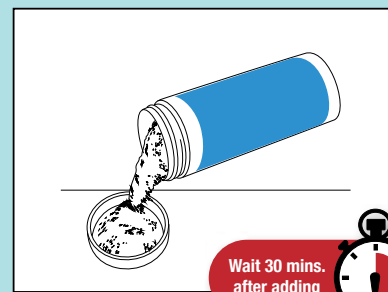

Wait 30 mins.  
after adding

#### Chlorine Granules

Add 15g per 1000L

### Step 4

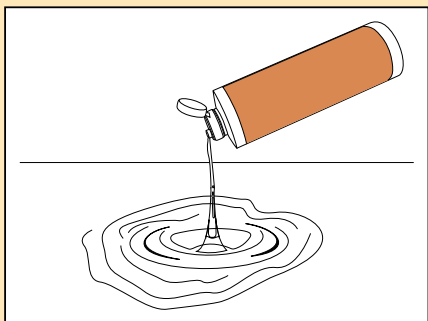

Use other chemicals  
(Spa Shock, Stain & Scale  
Control, Spa Flush) as needed



Use 80% less chlorine with  
our Glacier AO<sub>3</sub>P system!

## Chemical Kits Available



Starter Chemical Kit



Deluxe Chemical Kit

# MAINTENANCE SCHEDULE

## PROCEDURE

EACH  
USE

WEEKLY

3-4  
MONTHS

YEARLY

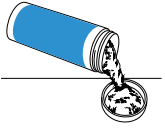

### SANITIZE

Replenish sanitizer levels with chlorine granules



### BALANCE

Balance your water according to Test Strip readings



### SPA SHOCK

Oxidize your water to remove combined chlorine and optimize the efficiency of your sanitizer

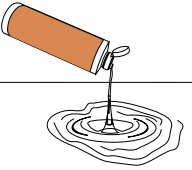

### SCALE CONTROL

Protect against hard water and metals which can leave a buildup or residue



### REPLACE SPA BALL

Absorbs film on the surface of the spa water and helps prevent scum lines on spa's acrylic



### REPLACE FILTER

Rinse with hose bi-weekly



### SPA FLUSH

Flush out build-up within your spa's pipes and internal components. Add gel and let cycle before draining spa water

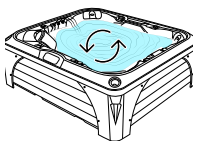

### CHANGE WATER

Drain and refill your water



### CHECK UV-C BULB *(purchased separately)*

Ensure Ozone LED is on during filter cycle



**REMINDER:** Your spa must be winterized if you are shutting it down for the winter



FOR MORE HELP GUIDES VISIT US AT:  
[libertyspas.com/support](http://libertyspas.com/support)  
 1-844-879-7727

# SPA WATER TEST APP

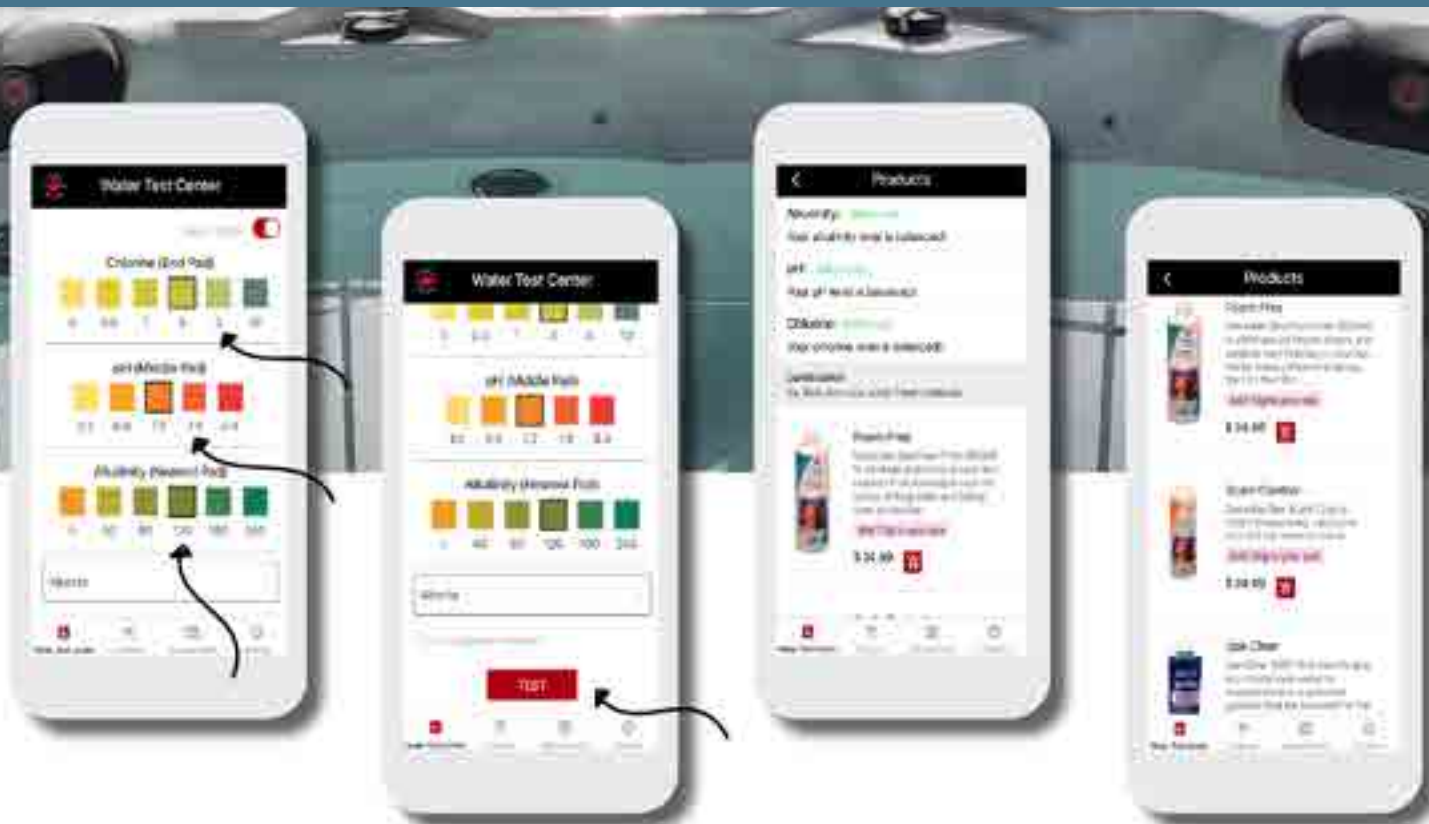

1. Dip your test strip into your spa water
2. Select the colors shown on the test strip into the "Water Test Center" screen of the app
3. Instantly you will have a custom guide to take care of your spa water!





# SPA WINTER CARE

## NOT USING YOUR SPA THIS WINTER?



### Winterization

**IMPORTANT:** If spa is being shut down for the winter season, it **MUST** be winterized.

Common problems that arise from leaving water in your spa during winter include moisture damage, and more costly, cracked pipes. This is because of water's unique property of expanding when frozen.

**SCAN**  
for winterization  
instructions and  
video



## ! MUST FOLLOW DURING WINTER SEASON !



### I just bought my tub in the winter months

- Use caution and use a space heater inside your spa's cabinet as directed in the instructions below to prevent freezing and damage to components while your spa is not in action.
- Have your spa winterized if you are getting it delivered in the winter, but do not intend to use it until the spring.
- **DON'T** start up the spa in freezing temperatures.



### NO water changes

- Draining and filling in the winter leads to freezing and damage to spa components.
- Wait until spring to change the water and work around the freezing temperatures.



### Have an action plan for winter vacations

#### Before you leave

- Ensure water and chemical levels are normal.
- Change your filters if it's time to do so (every 3-4 months).
- Lock your cover to protect from winds and keep unwanted visitors out.
- Cover guards are available for an extra layer of protection from ice, snow and tree sap on your cover.

#### While you're away

- If you're gone longer than a week, have someone check up on the spa and keep up with the recommended chemical schedule.
- We recommend signing up for a **Mr. Spa maintenance package!**



### In the Event of a Power Outage

- Place a space heater inside spa cabinet to help reduce the risk of freezing.
- Use a ceramic space heater.
- Do not have it blowing directly on or touching equipment. There are a lot of open areas to place it near the pump.
- Set space heater on a lower setting to prevent heat damage to the spa cabinet.
- **DON'T** keep opening your cover to check on the spa. You lose a lot of heat by doing this.

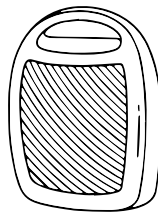

### SCAN TO LEARN MORE ABOUT



## TIPS FOR WINTER USE



### Close air dials in the winter

- Keep your air dials **CLOSED** after each spa session to hold the heat in your spa cabinets, instead of letting cold air through to cool down the water.



### Keep tub in Ready Mode and NOT Rest Mode

- Keep your spa in Ready Mode to maintain heat when your spa is not in use.



### Use your spa in the winter!

- If you are able to use your spa in the winter, that is the best! It is important to use your spa components for longevity.
- Follow the same water chemical procedure in the winter.





# WARRANTY INFO

**NEED ASSISTANCE?  
WE'RE HERE TO HELP**

**NOTE \* WE REQUIRE THE FOLLOWING INFO WHEN CONTACTING US:**

**First/Last Name**

**Email Address**

**Phone Number**

**Brief Description of Issue**

Ex. Bob Brown

Ex. Bob@gmail.com

Ex. 123-123-2345

Ex. Jets not working



1. Register your warranty at: [libertyspas.com/warranty](https://libertyspas.com/warranty)



3. Create a service ticket at: [libertyspas.com/support](https://libertyspas.com/support)



4. Give us a call. Multiple languages supported: **1-844-879-7727**



5. Email us at: [sales@libertyspas.com](mailto:sales@libertyspas.com)

# LIMITED WARRANTY

**Structural Warranty:** CSC warrants structure of the spa shell against water loss due to structural failure for a period of **\*year(s)** from the date of purchase by the original owner. If in CSC opinion, structure proves to be defective, CSC will repair or, at its discretion, replace the defective structure without charge to the customer.

**Surface Warranty:** CSC warrants the acrylic finish against defects in material and workmanship and specifically against blistering, cracking or delamination for the period of **\*year(s)** from the original purchase date to the original purchaser. If, in CSC opinion, the surface proves to be defective during this period, CSC will repair or, at its option, replace the defective spa shell without charge to the customer.

**Equipment/Plumbing Warranty:** CSC warrants the functional equipment and plumbing of the spa remain free from defects in material and workmanship for a period of **\*year(s)** from the date of purchase by the original purchaser.

**\*Acrylic Portable Spas:**

**Structure:** 5 years

**Surface:** 1 year

**Equipment/plumbing:** 1 year

**Floor models purchased from an authorized retailer:** 1 year parts replacement warranty

**\*Acrylic Non-Portable Spas:**

**Structure:** 10 years

**Surface:** 2 years

**Equipment/plumbing:** 2 years

**Floor models purchased from an authorized retailer:** 2 year parts replacement warranty

**Extent of Warranty:** This Limited Warranty applies to spas manufactured after **January 1, 2025** and sold by authorized CSC dealers to residential retail customers. This Limited Warranty is given only to the first retail purchaser and terminates upon transfer of ownership. No warranty is provided on any dealer installed accessories. Cost of installation, removal and/or shipping of the spa is not covered by this Limited Warranty. In the event CSC deems necessary the removal of the spa to a place of repair or that the spa must be replaced, any and all costs of the spa removal and replacement; landscaping, decking, fencing and/or structure removal, alteration and/or replacement; or other costs of providing access to the spa will be for the purchaser. This Warranty applies only to spas in single family, residential installations. This Limited Warranty becomes void if the spa is placed in commercial application.

**Installation:**

Spa must be installed by a licensed and certified electrician for a valid manufacturer warranty. Customer is responsible for proper permits and certifications to ensure spa is installed correctly. Proof of this installation may be required by our team as requested. Failure to improperly install the spa (including use of aluminium wire or no proof of proper installation) will void the warranty.

**Gazebo Warranty:** CSC provides a **one (1) year** parts only warranty for authorized purchases of gazebos through CSC or their authorized dealer.

**TERMS, CONDITIONS AND LIMITATIONS**

Any defect or damage caused by installation, alteration or repair by anyone who is not an employee of CSC or authorized service technician is not covered by the Warranty. This Warranty becomes void if the spa has been subjected to misuse, abuse, alteration or attempted alteration, repairs or attempted repairs by anyone other than an authorised CSC service technician. Improper installation, improper water chemistry, improper maintenance, acts of god, or damage caused beyond the control of CSC is not covered. Misuse and abuse shall include any operation of the spa other than as directed in the CSC Manual. Failure to properly winterize the hot tub as per CSC will cause freezing damage and is not covered under this warranty.

Examples of misuse and abuse include, without limitation:

- Damage of the spa surface caused by leaving the spa uncovered while the spa is empty of water or due to covering the spa with plastic film of any kind.
- Damage to the spa surface caused by contact with unapproved cleaners or solvents.
- Damage caused by the operation of the spas at water temperatures outside of the range of 2 – 40 degrees Celsius.
- Damage caused by unapproved sanitizer such as calcium hypochlorite, tri-chlor type chlorine or any sanitizing chemical that may remain undissolved on the spa surface.
- Damage caused by failure to provide an even base support for the spa.
- Damage caused by freezing when new spa is not installed within a timely manner during below freezing temperatures.
- CSC spas require genuine approved CSC filters, and use of non genuine approved CSC filters will void the warranty.
- Damage to spa cover or hot tub as a result of adding chemicals to the water without removing the spa cover.
- Customer is responsible for returning faulty warranty parts, otherwise customer will be charged for the unreturned equipment.

**Warranty Performance:** In the event of a defect covered under the terms of this Limited Warranty, notify your authorised CSC dealer and create a ticket at support.canadianspacompany.com. A CSC authorised service technician will repair the spa subject to the Terms and Conditions of this Limited Warranty. CSC will use genuine parts that have been factory certified to repair the hot tub. Use all reasonable means to protect the spa from further damage. Reasonable travel charges may be assessed by CSC or its authorized service technician if the spa is located outside the nearest authorized service technician's service area. This warranty covers parts ONLY and does not include travel or on-site service charges unless a Service Contract has been purchased from CSC. Proper access must be provided to all sides of the spa at the cost of the customer in the extent of a warranty claim. Failure to provide access will nullify the warranty.

**Disclaimers:** CSC or any of its authorized service technicians shall not be held liable for injury, inconvenience, loss of use, chemical or water damage, transportation costs, contingent liabilities or any other incidental or consequential costs, expenses or damage as result of any deficiency or alleged deficiency of the spa. In no event shall CSC be liable, for any reason or cause, in excess of the amount paid for the product. No other warranties, expressed or implied, are valid. No agent, dealer, distributor, Service Company or other party is authorized to change, modify or extend the terms of this Limited Warranty in any manner whatsoever. Warranty is only valid with a proof of purchase and manufacturers plate/serial number. Cosmetic damage or normal wear and tear is not covered by the warranty.



FOR MORE HELP GUIDES VISIT US AT:  
[libertypas.com/support](http://libertypas.com/support)  
1-844-879-7727

**USA Head Office:**  
10908 S Jordan Gateway,  
South Jordan, UT 84095  
T:1-844-879-7727

**Canadian Head Office:**  
1283 Cornwall Rd,  
Oakville, ON L6J 7T5  
T:1-877-909-7727

**Atlantic Office:**  
65 John Savage Ave Unit 6  
Dartmouth, NS B3B 2C9  
T: 1-877-909-7727

**European Head Office:**  
Canada House  
Salbrook Road, Salfords, Redhill  
Surrey, RH1 5GL  
T: +44 1293 824094

CSC meets ISO 9001 Standards. When you purchase a hot tub from CSC, the ISO 9001 certification assures world class excellence in manufacturing and customer service.





**USA Head Office**  
10908 S Jordan Gateway  
South Jordan, UT 84095, USA  
1-844-879-7727

**libertyspas.com**



**SCAN** to download

01.01.2025 | KM-10227 - KH-10205