

User Manual

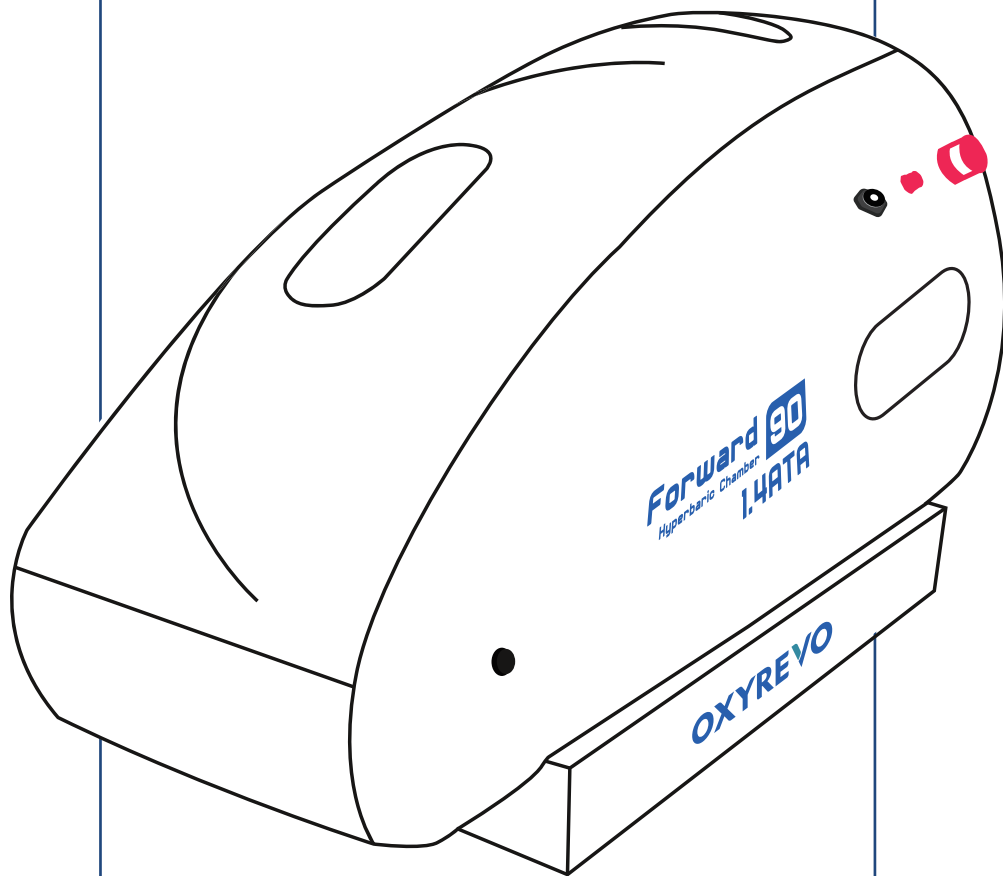

OXYREVO

www.oxyrevo.com

Safety Notice

To ensure safety, please read the following precautions before using,

Warning:

- If abnormal smell during use, please turn off the power and pull out the plug
- Please make sure the socket plug is fully inserted
- Please do not disassemble the machine without permission from the supplier
- This product must not be exposed to water, fire, or sharp objects
- Child use under adult care only
- Please do not touch any valves on the chamber when in use
- Please do not place heavy objects on the machine
- Do not use if the power cord is loose
- Do not pull or twist the power cord
- Keep wet hands away from the unit
- Do not use it in a bathroom or other damp environment

Do not use under the following conditions:

- Pregnant women and people with severe infectious diseases
- Bad colds and Pneumothorax patients
- Patients with severe emphysema
- Hypertension exceeds 160 / 100ml
- Severe heart problems

*It is recommended to turn on your room air conditioner when your room temperature is above 20°C for better comfortable cooling using experience .

Notice:

1. When the pressure is rising in the chamber, your ears may sense the pressure, similar to the feeling of taking a plane up and down.

This is normal. The following methods can be used to relieve the pressure,

- a) Chewing gum.
 - b) Yawning.
 - c) Pinch nose and blow against a closed mouth until the pressure stabilizes.
- Any discomfort will gradually disappear.

2. Zippers can be opened ONLY when the chamber has been depressurized to 0kPa.



Open the Valve

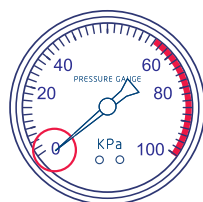

Make sure that Pressure Gauge appears 0 kPa

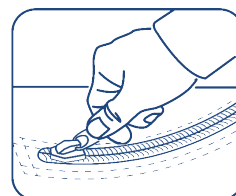

Pull the zippers

3. After exiting the chamber, turn off power to the unit.

Specifications

1. Chamber Capsule

1	Window	7	Internal Pressure Gauge
2	Zippers	8	External Pressure Gauge
3	Automatic Pressure Relief Valves	9	Spare Valve
4	Air Inlet Valve	10	Emergency Pressure Relief Valve
5	Oxygen Inlet Valve	11	Pressure Switch Valve
6	Pressure Deflate Valve	12	Anti-roll Bolsters

Model	HYPERBARIC CHAMBER Forward90
Specification	
Size	230*120*120cm
Pressure	1.4ATA/1.5ATA
Weight	15kg/17kg

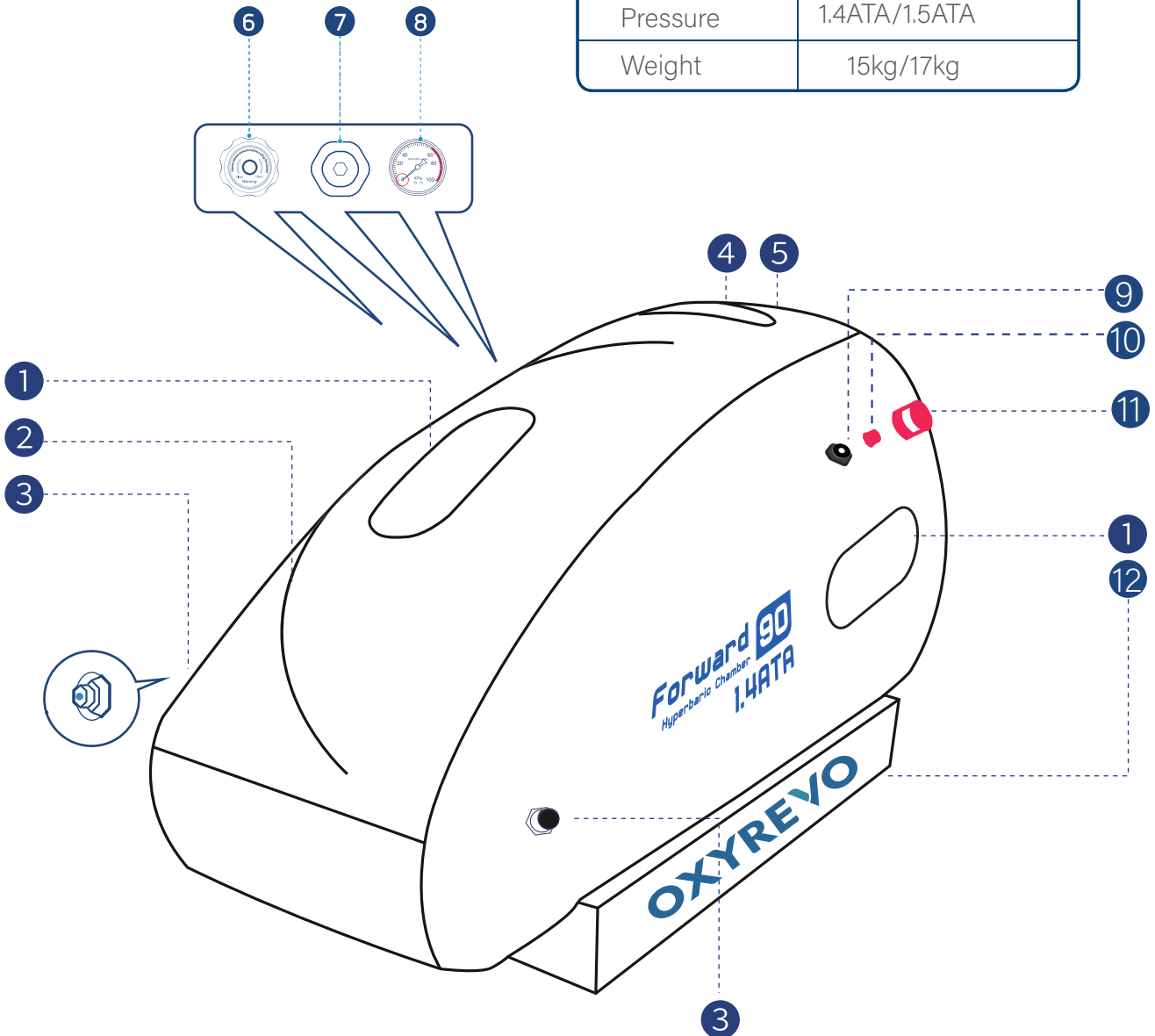

Specifications

2. Oil Free Air Compressor

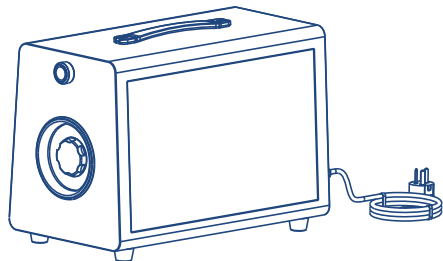

Oil Free Air Compressor	
Voltage	110V/220V
Air Flow	85L/Minute
Power	400W
Weight	18KG

3. Oxygen Concentrator

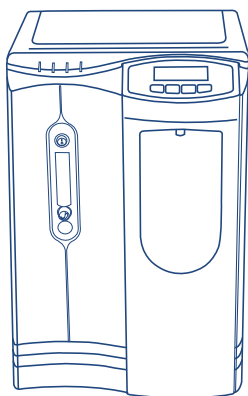

Oxygen Concentrator	
Voltage	110V/220V
Oxygen Flow	1-10L/Minute
Power	350W
Weight	30KG

4. Air Cooler

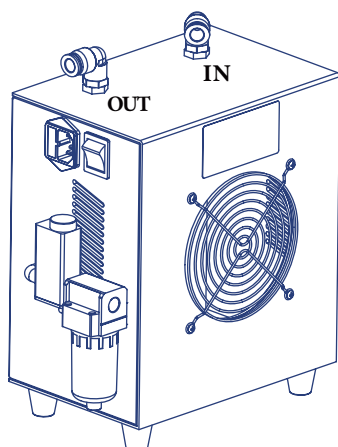

Air Cooler	
Voltage	110V/220V
Capability	150L/Minute
Pressure	0.8mPa
Power	220w
Weight	7kg



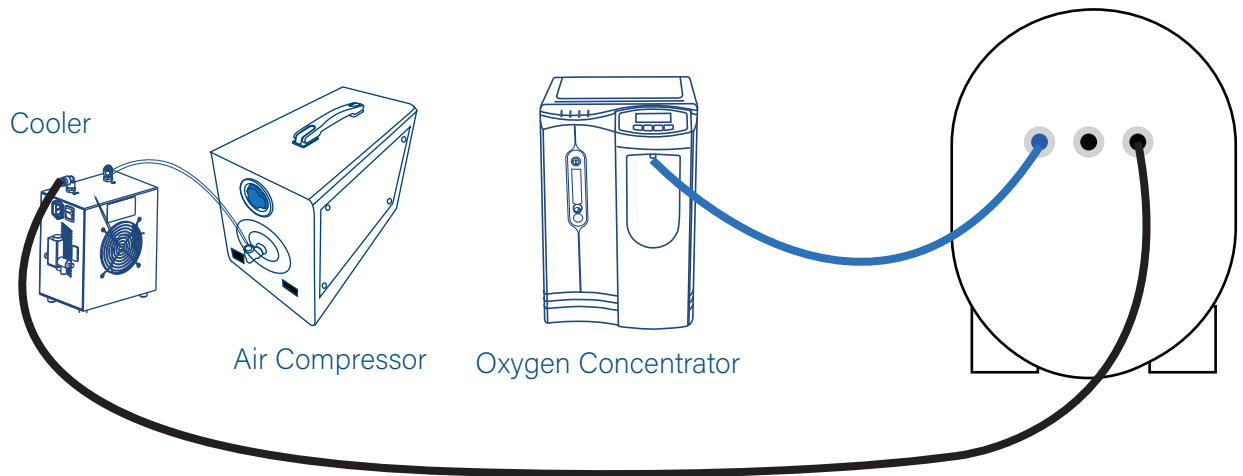

Assembly and Operation

1. Working Scheme

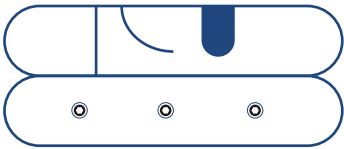
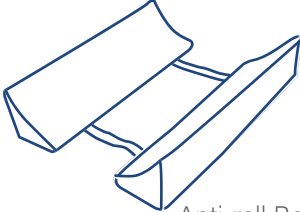
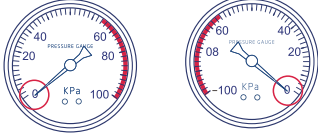
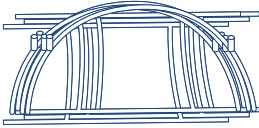

2. Installation

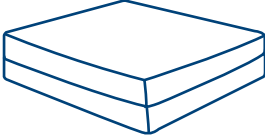
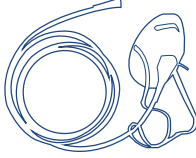
1. Please check the items before beginning installation.

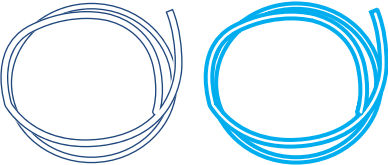
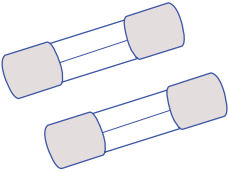
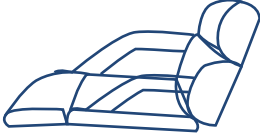
 Chamber	 Anti-roll Bolsters	 Internal/External Pressure Gauge
 Frame	 Silencer	 Spare Activated Carbon Cotton Filter
 Mattress	 Oxygen Mask	 Hexagon Wrench
 Air Tube and Oxygen Tube	 Spare Fuse	 Folding Chair

Assembly and Operation

2. a. Connect the **Transparent** tube from Air Compressor to the Wet Air **In** port in Cooler.
b. Connect the **Black** tube from Dry Air **Out** port in Cooler to the **Air Inlet Valve(Black)** of the chamber.
c. Connect the **Blue** Oxygen Tube from Oxygen Concentrator to the **Oxygen Inlet Valve(Blue)** of the chamber.

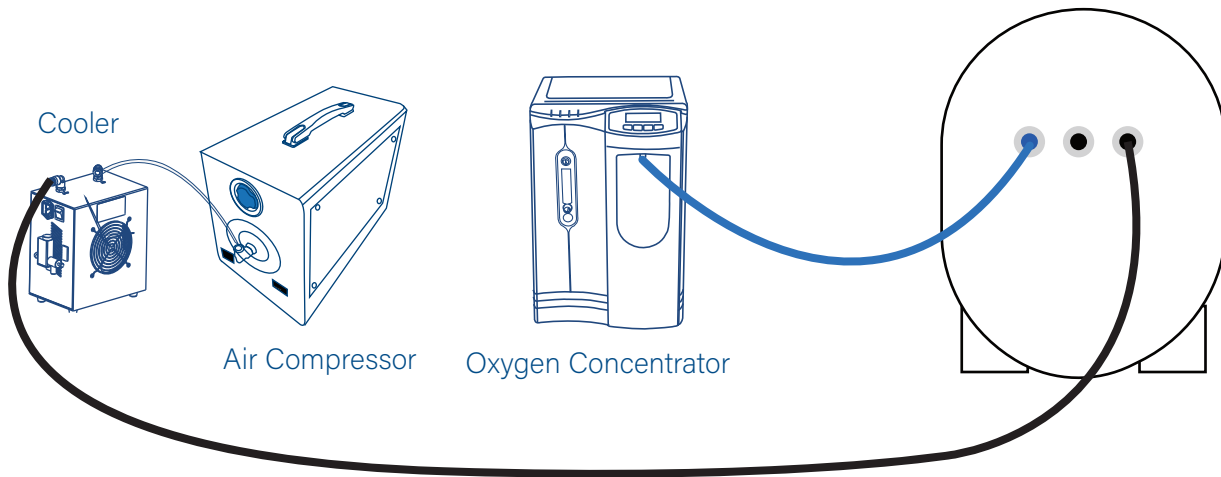

- d. Install internal&external pressure gauges.

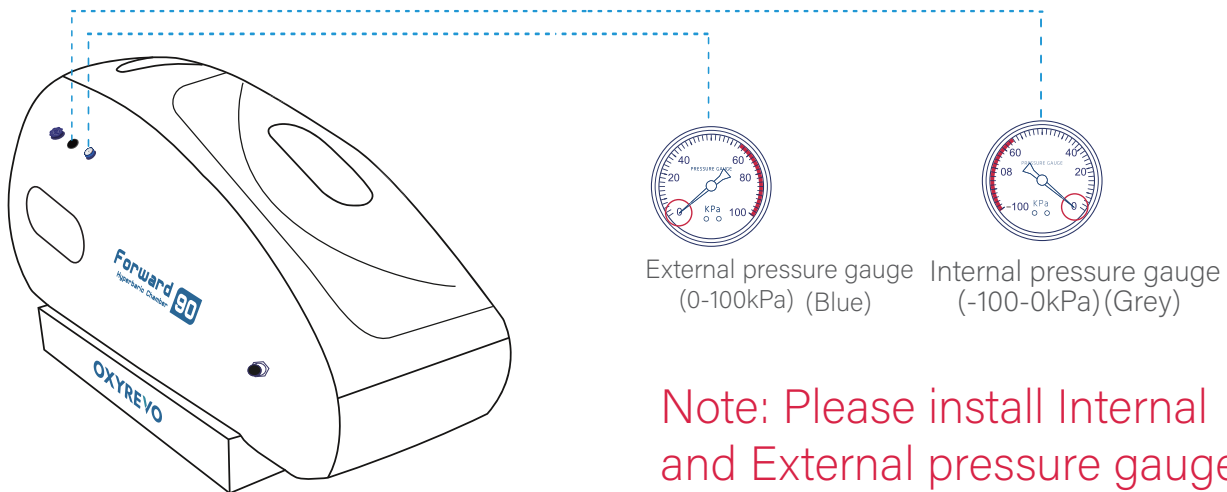

External pressure gauge (0-100kPa) (Blue) Internal pressure gauge (-100-0kPa)(Grey)

Note: Please install Internal and External pressure gauges before using.

- a. The Internal pressure gauge should be installed **INSIDE** the chamber.
- b. The External pressure gauge should be installed **OUTSIDE** the chamber.

Assembly and Operation

3. Install the metal frame (must be installed inside the chamber - it is recommended to take all frame pieces into the chamber, then install the frame while inflating the chamber for the first time). Hold and tighten the frame rods by the locked tube jointers provided (as shown below).

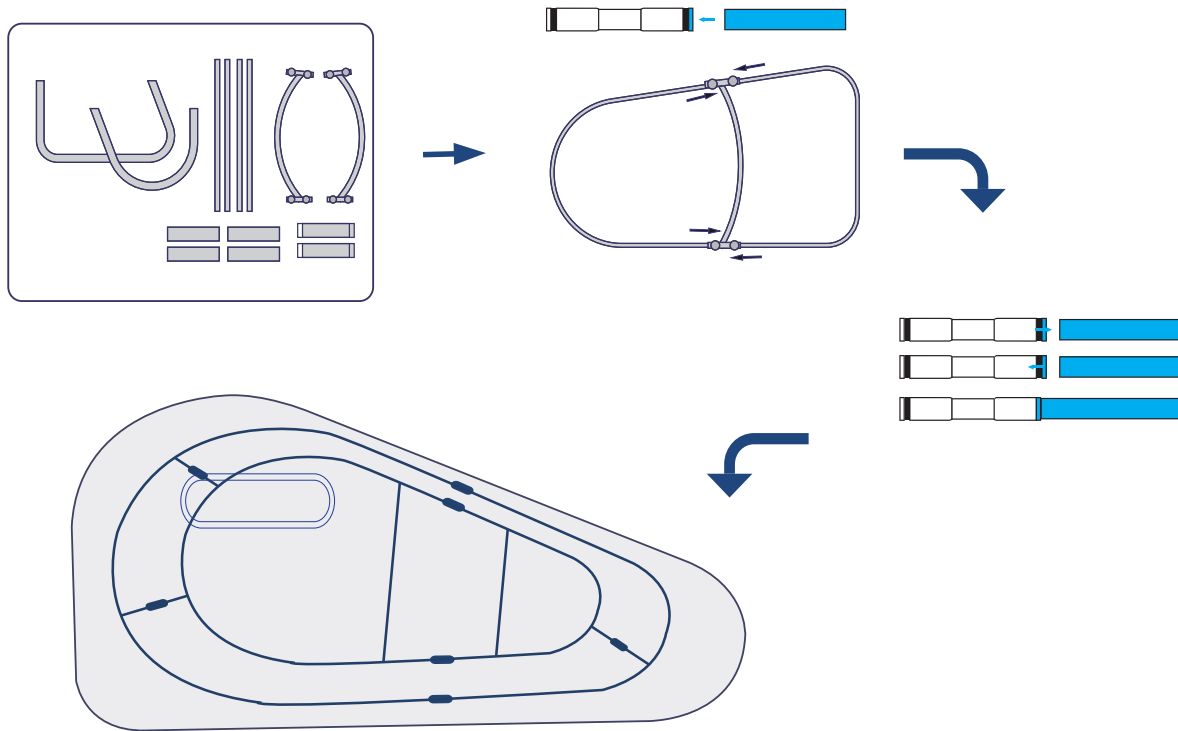

4. The Silencer is mounted to the **Air** inlet valve (**Black**) inside the chamber.
The Oxygen Mask/Headset is mounted to the **Oxygen** inlet valve (**Blue**) inside the chamber.

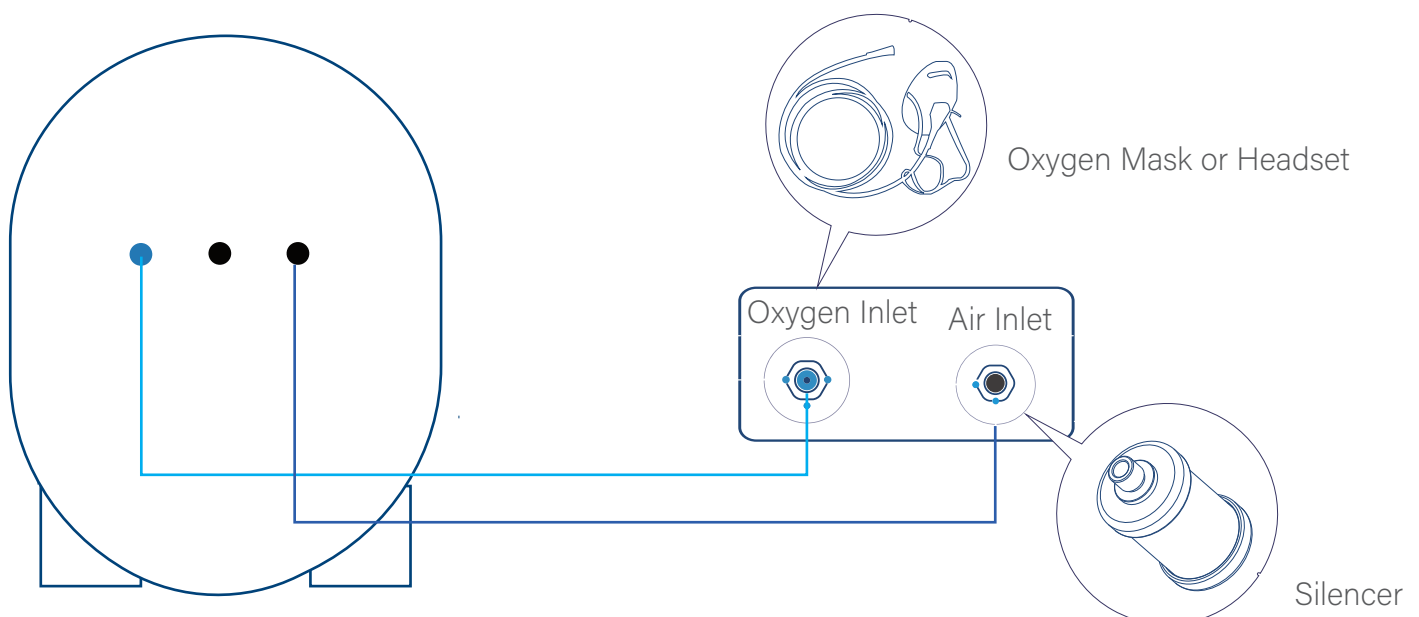

5. Install the mattress and put anti-roll bolsters under the chamber.

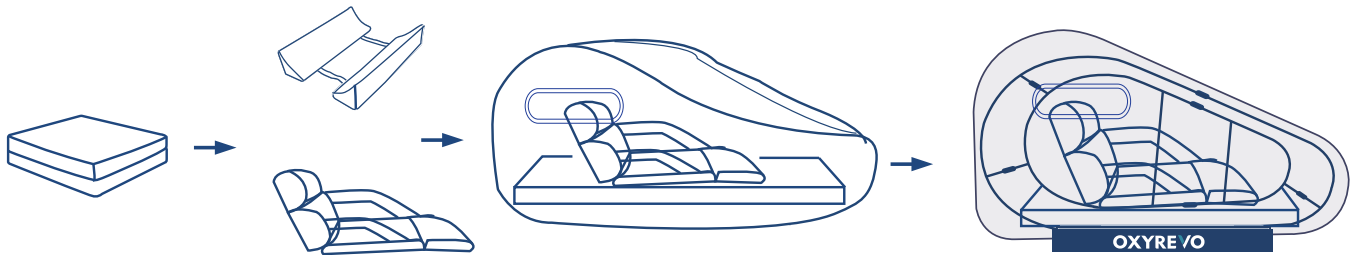

6. Turn on the machine units.

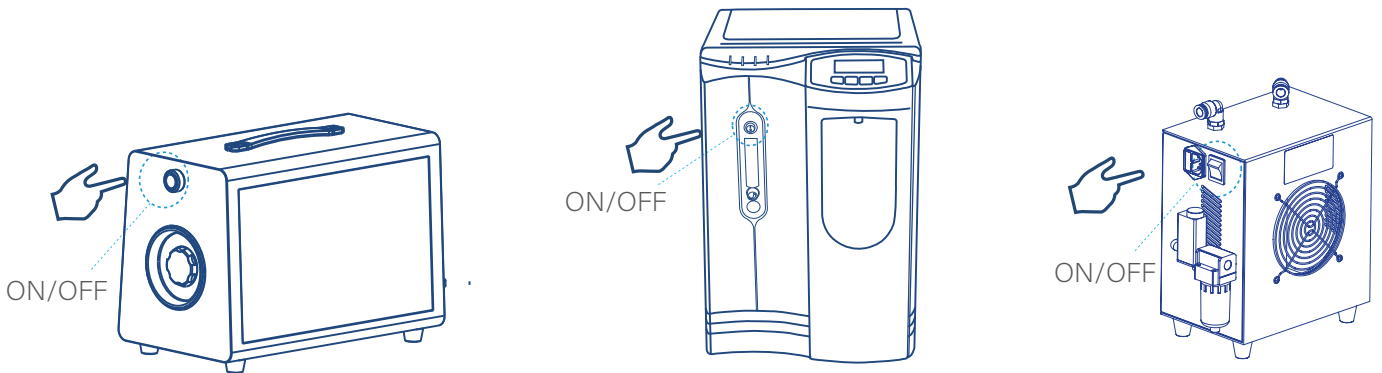

7. Get into the chamber, close inside and outside zippers.
(be sure to flatten out the silicone seal strip between the zippers)

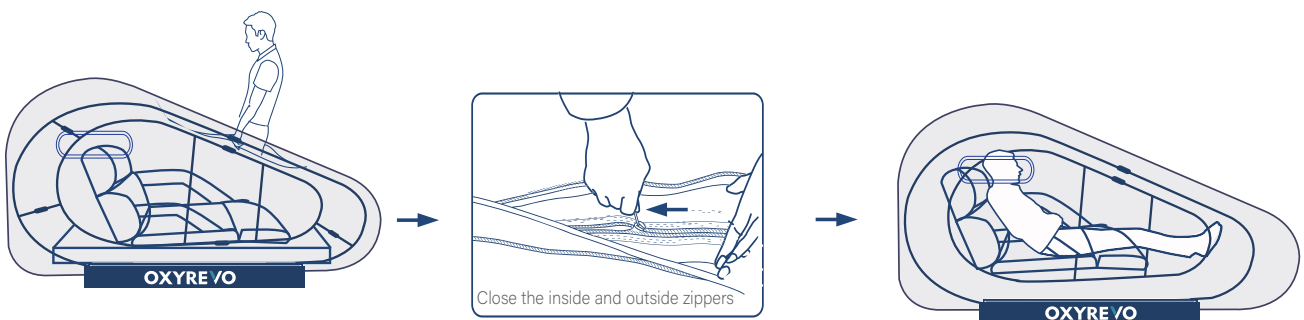

8. Close the manual pressure deflate valve.

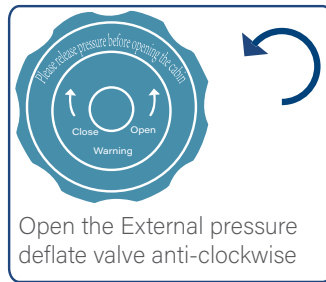
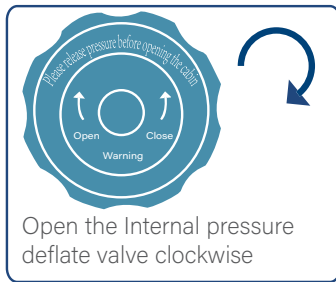

Pressure Deflate Valve can be operated inside and outside both of the chamber.
Note: either valve may be used to deflate the chamber.

9. Lie down and put on oxygen headset or mask.

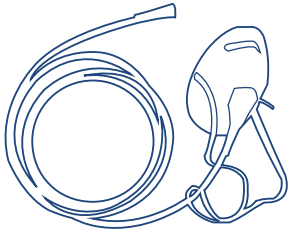

Oxygen Mask

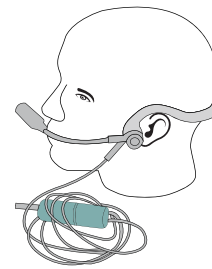
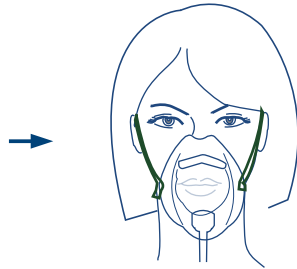

Headset Oxygen Breathing Unit

10. In about 8-10 minutes, the chamber pressure gauge will slowly rise up to 40kPa/1.4ATA, or 50kPa/1.5ATA, (depends on the chamber you purchased)
At this time the automatic pressure release valve will exhaust air automatically to maintain the pressure.

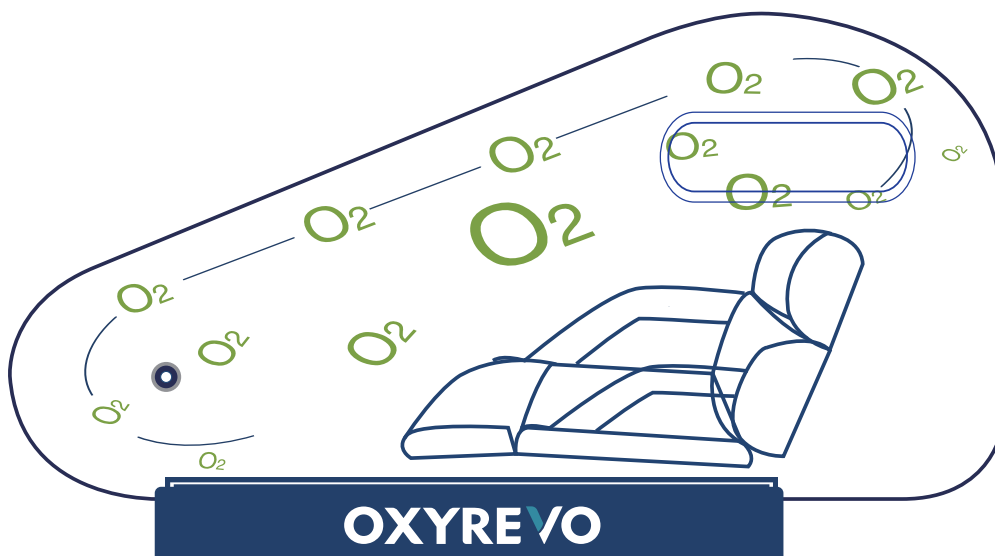

Assembly and Operation

11. The recommended session time is 60-90 minutes per session.

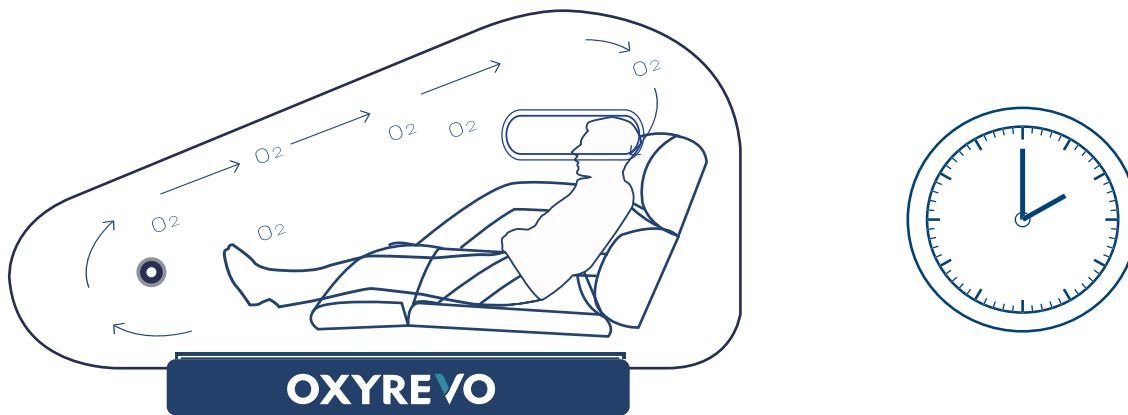

12. After the session, turn the Manual Pressure Deflate Valve to deflate the chamber.

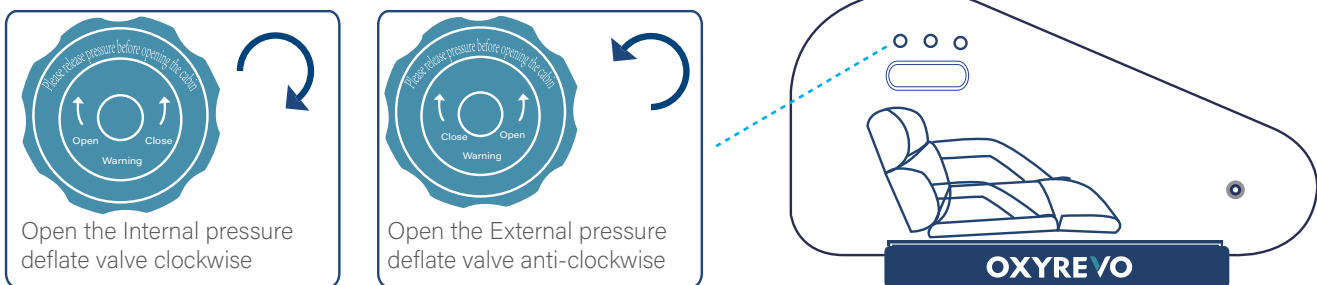

*Pressure Deflate Valve can be operated inside and outside both of the chamber.

13. When the pressure gauge shows 0kPa, open the zippers and exit the chamber.

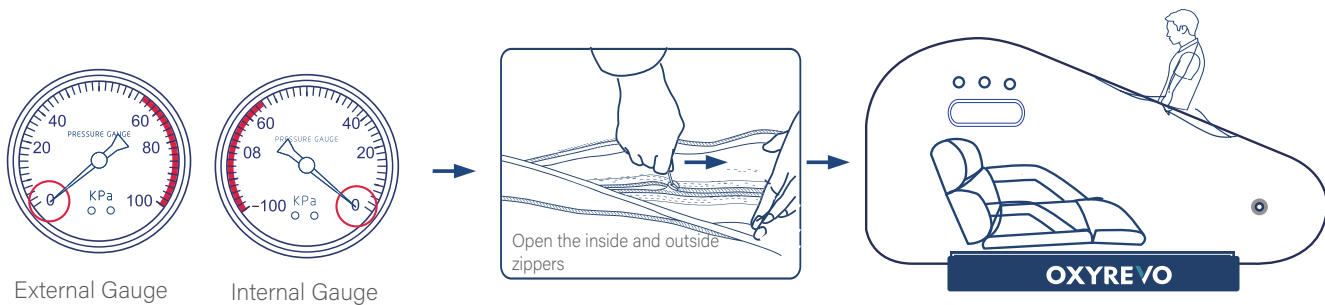

14. After exiting the chamber, turn off the machine units.

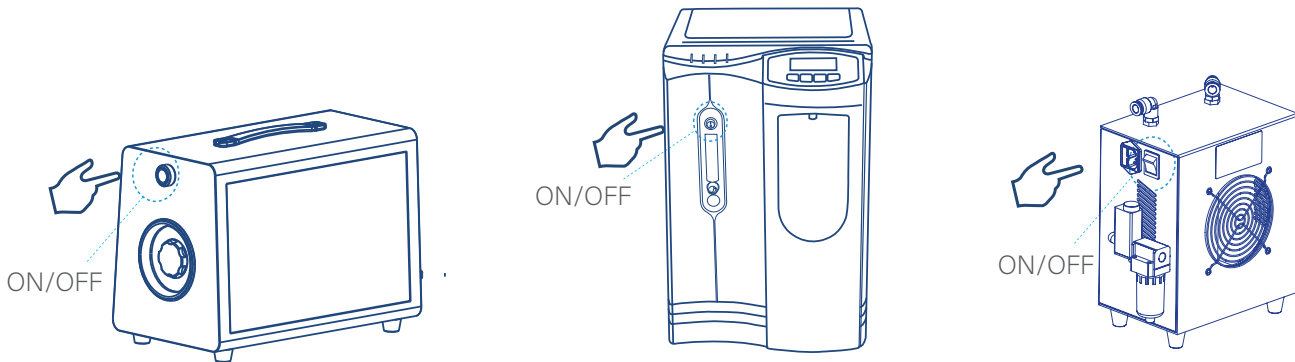

15. Tips for Water Container,

a. There is a water container in front of the cooler unit. – empty the contents.

b. Take it off from the holder and empty the container after session finished and machine off.

*The cooling system lowers the humidity inside of chamber for a more comfortable experience.

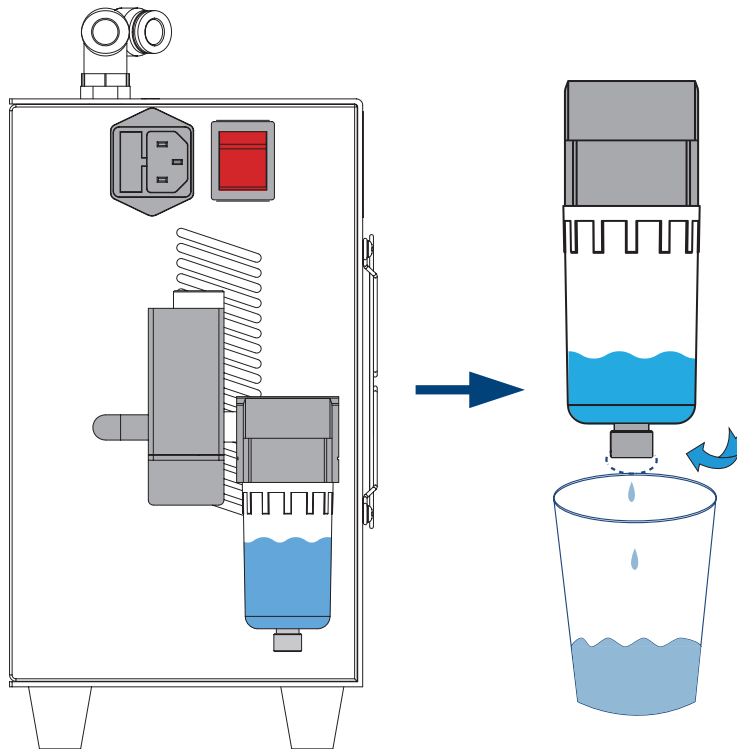

1. Chamber Maintenance and Cleaning

If necessary, clean the inside of the chamber with a damp/antibacterial cloth and run under pressure for 20 minutes until dry.

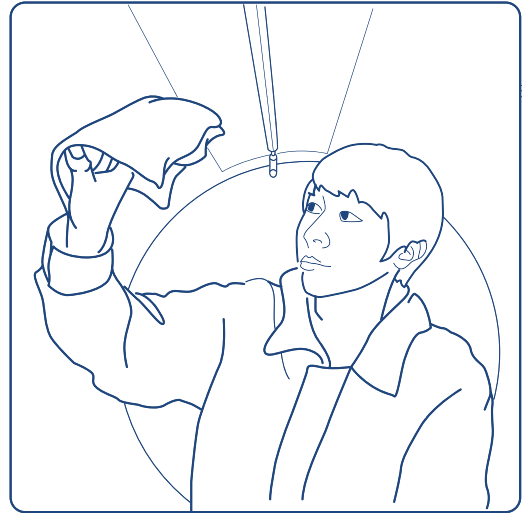

2. Oil Free Air Compressor Unit Maintenance and Cleaning

- Take off the filter containers and replace the filters (see below)
- Replace the activated carbon cotton filters every 6-12 months (depending on frequency of use).

Take out the filters and replace with new ones ●

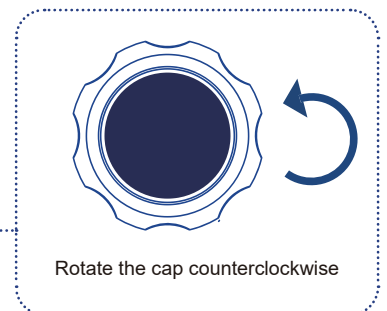
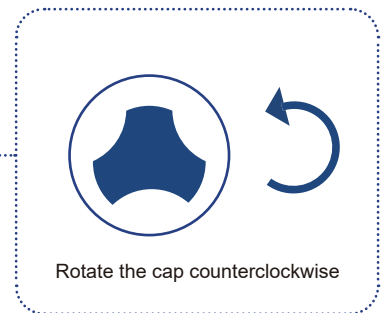
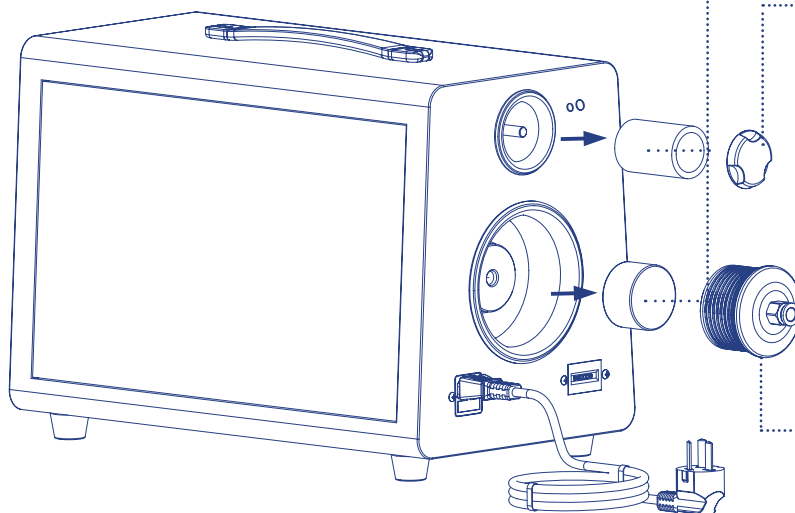

3. Oxygen Concentrator Unit Maintenance(Air Filter Replacing)

- a. Take off the filter covers in each side of the oxygen machine unit.
- b. Take off the filter.
- c. Replace with new filter.

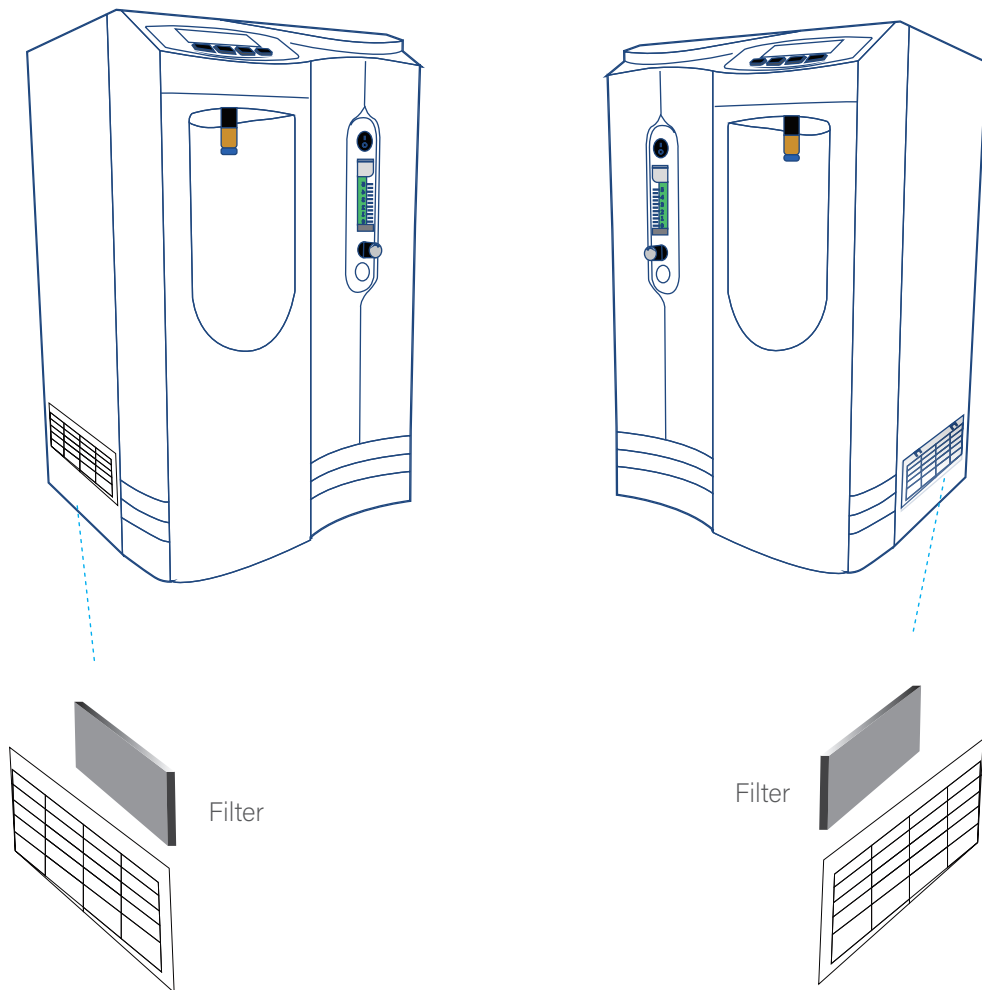

Precautions



When using for the first time, please test the empty chamber first and observe whether the equipment is operating normally. If the equipment is running abnormally, please do not use it, and contact your dealer promptly.



When you exit the chamber, wait until the pressure gauge shows 0kPa before you open the inner and outer zippers. Do not force the zipper to open during use or when pressure relief is not complete.



In the event of an emergency or if the air deflate valve fails to operate properly, push the emergency relief valve from inside the chamber to relieve pressure. When the pressure is 0, pull the zipper and get out of chamber.



When you use the device for the first time, there may occur slight discomfort or pain in your ears. This is a normal phenomenon caused by pressure increase. The best way to relieve this is to pinch your nose shut and attempt to blow through your closed mouth.



Please place all the machines away from the wall in an open area for better heating spreading produced when machines running.

1. Clothing

- Wear the loose, comfortable clothes.
- You may bring electronic products/drinks into the chamber.
- Ladies should remove long socks (stockings). Please take off shoes before getting in.
- Shoes, jewelry, or any sharp objects that could damage the chamber should be removed.
- Disposable foot and hair covers may be used.
- To make the therapy experience more pleasant, you should get as comfortable as possible - that means taking care of restroom breaks and/or drinking water before getting into the chamber.
- The user should be advised to relax and breathe normally.

2. Chamber Pressurization

During the pressurization, some people may feel pain in the ears due to pressure on the tympanic membrane. This is normal and easily relieved. Chewing (gum) or repeated swallowing often equalizes this pressure. You can also pinch the nose shut and blow through closed mouth (as divers do). However, if the Eustachian tubes are blocked (due to a cold or allergy), the pressure cannot be equalized, and the user should terminate the session. The user can also slow the pressurization process by using the internal deflation pressure valve. When a session is finished, unscrew the air deflate valve to depressurize the chamber - the pressure will drop slowly from 40/50kPa to 0kPa - this depressurization process should take about 5-10 minutes. When the pressure gauges appear 0kPa, zippers can be opened, people can get out, and machines turned off.

Warranty

All products come with 2 years of warranty from the date of delivery. During the warranty period, if there are any faulty materials and/or workmanship on the system (when properly operated), repair or replacement will be offered.