

## LIBERA

### Installation manual

Dimensions:

120x180 cm

150x180 cm

150x200 cm

200x200 cm

200x250 cm

Handedness:

Left



# Leave space for better assembly

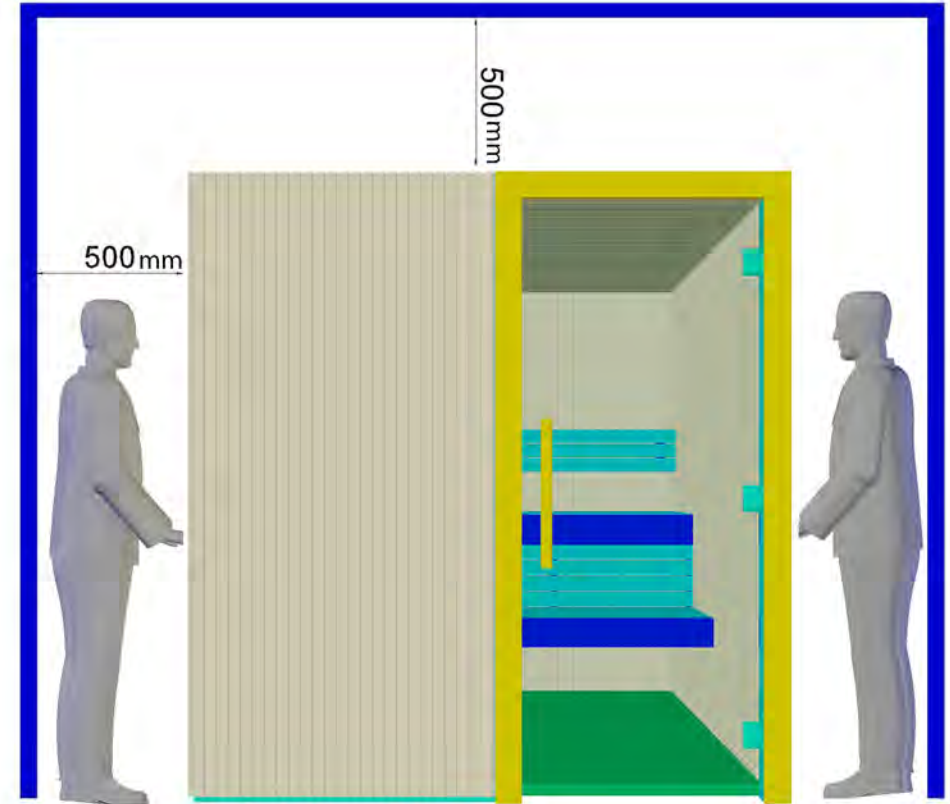
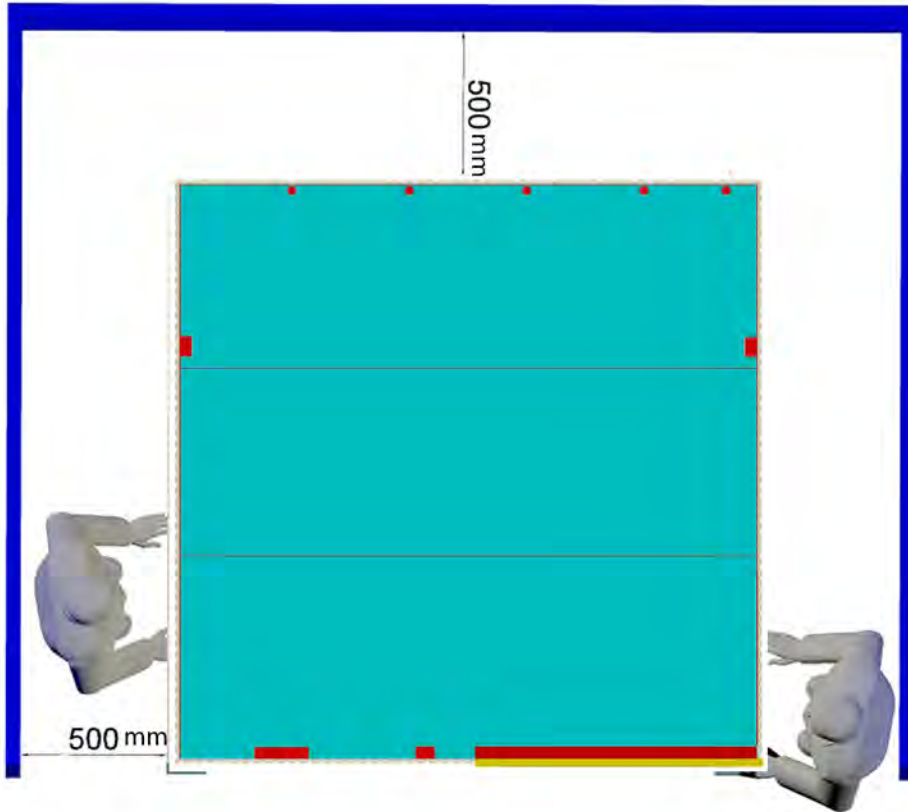

# Tools



# 1. Base frame

	x (mm)	y (mm)
120x180 cm	2115	1770
150x180 cm	2293	1770
150x200 cm	2451	1970
200x200 cm	2778	1970
200x250 cm	3152	2470

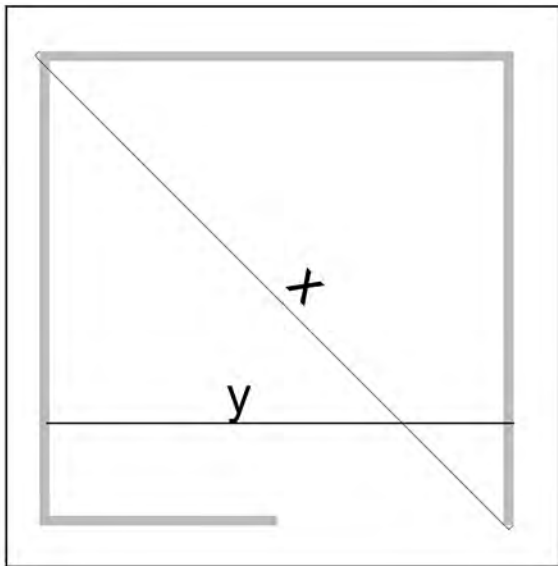
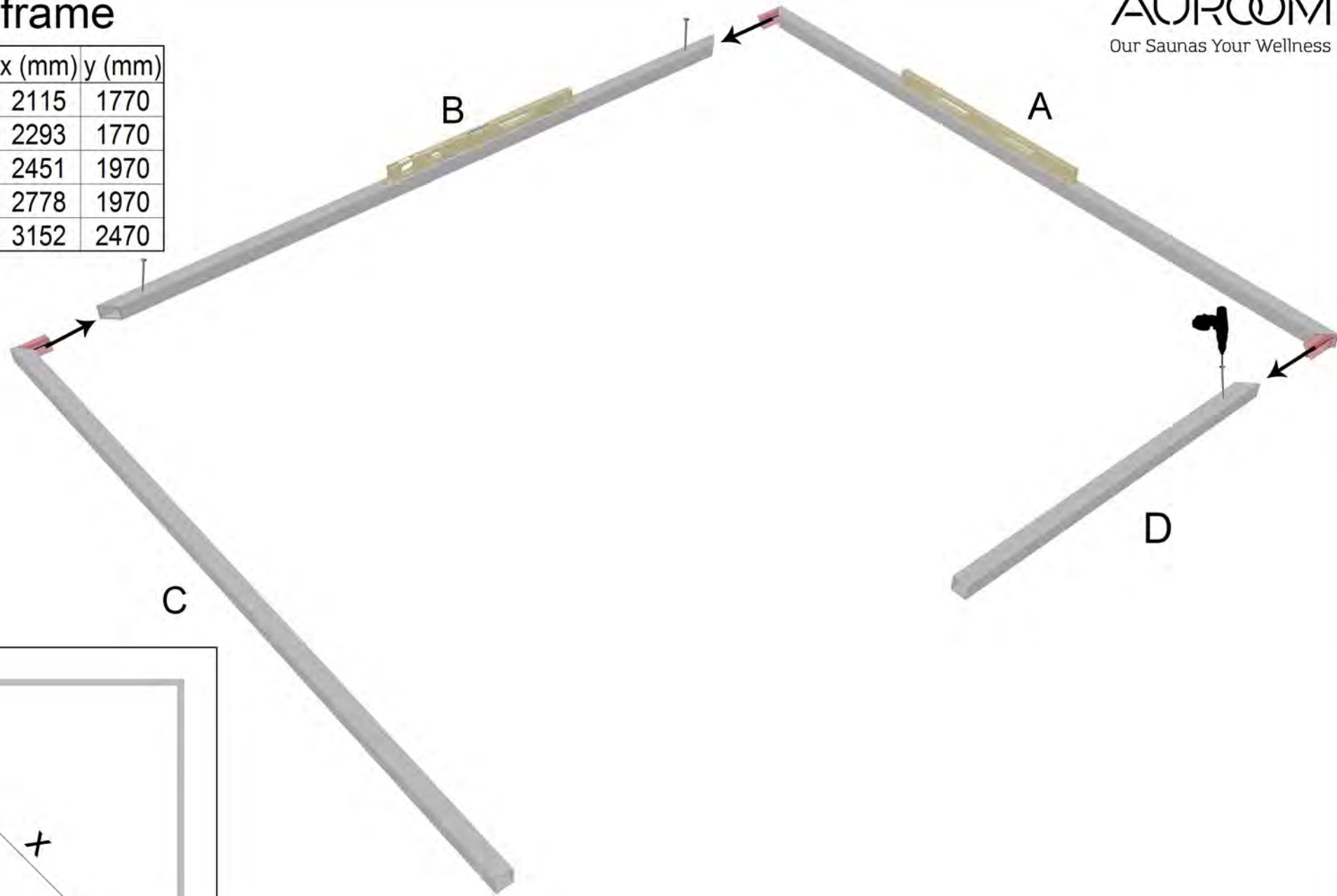

## 2. Walls

	Number of wall elements			
	A	B	C	D
120x180 cm	2	3	2	2
150x180 cm	2	3	2	2
150x200 cm	2	3	2	2
200x200 cm	3	3	3	2
200x250 cm	3	4	3	3

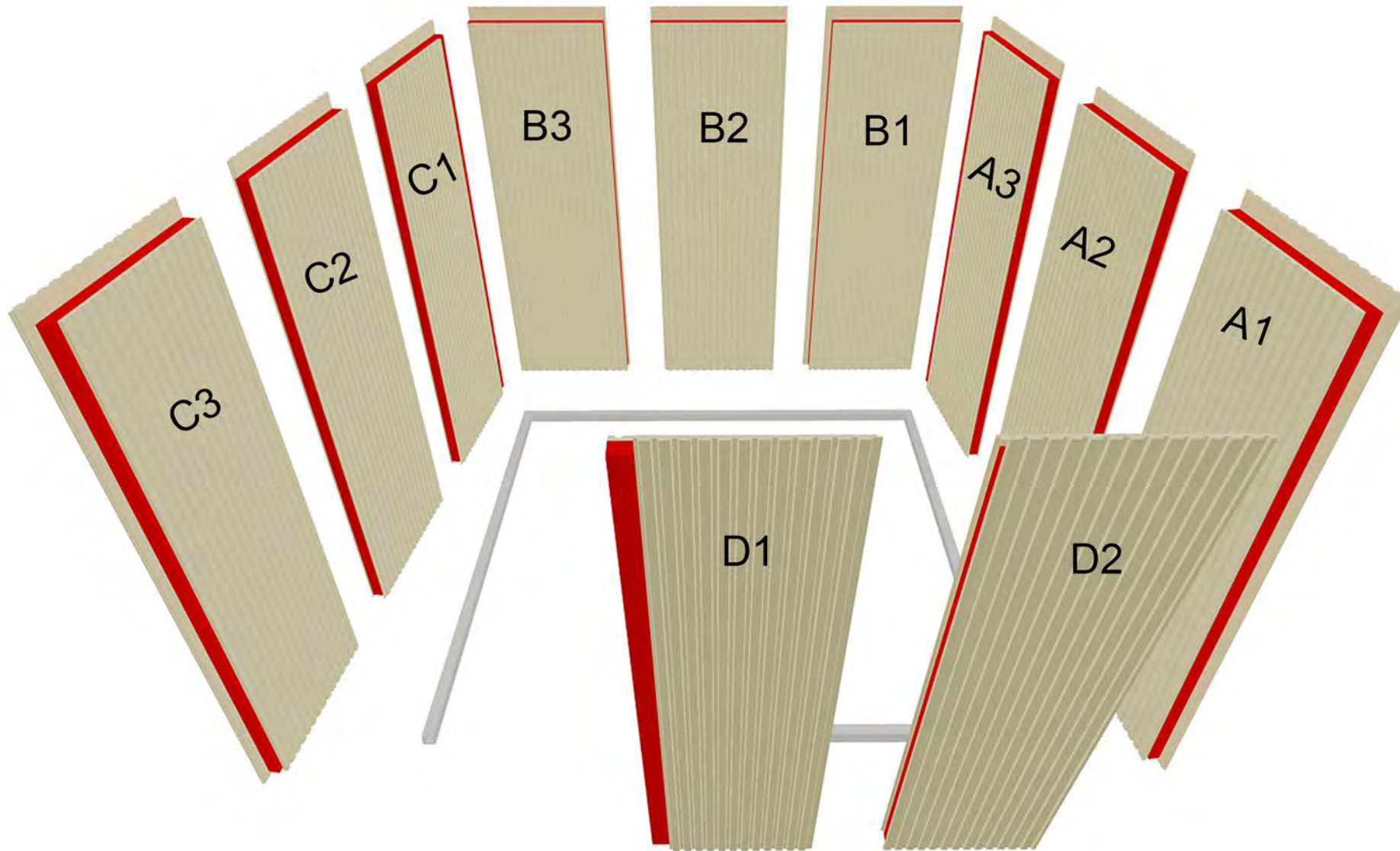

### 3. Multiclip closing system

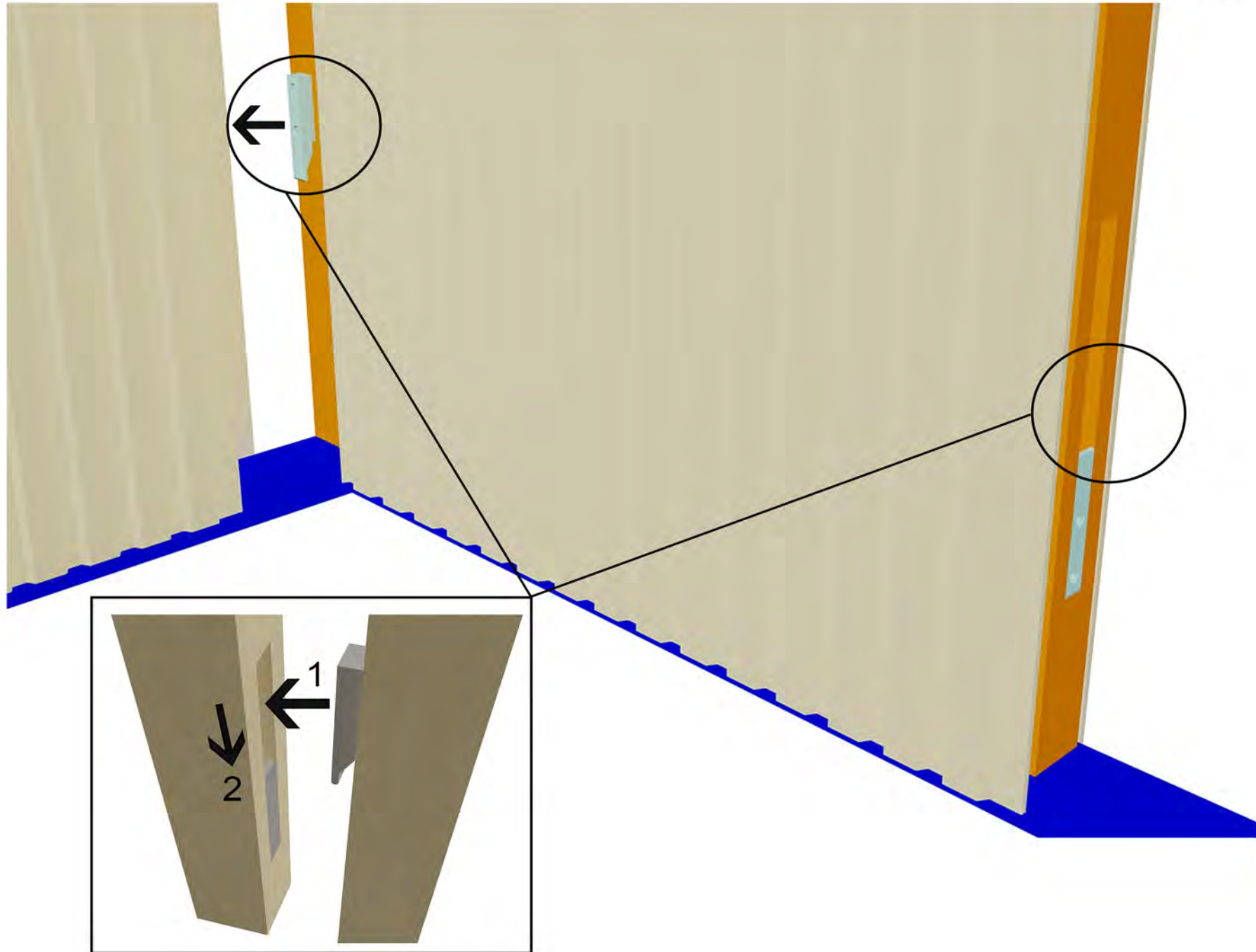

# 4. Fixing first corner walls

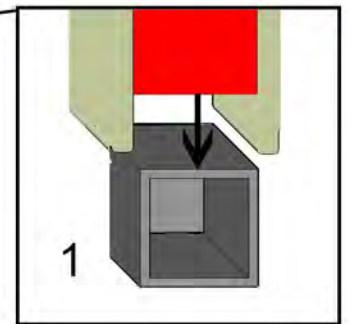
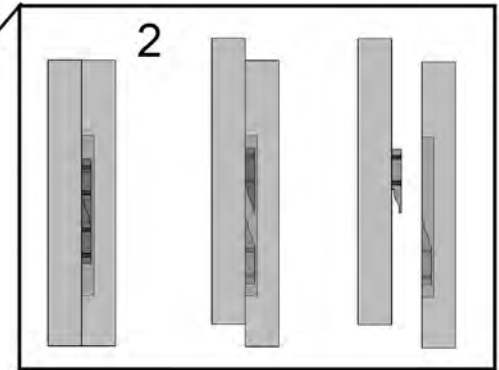
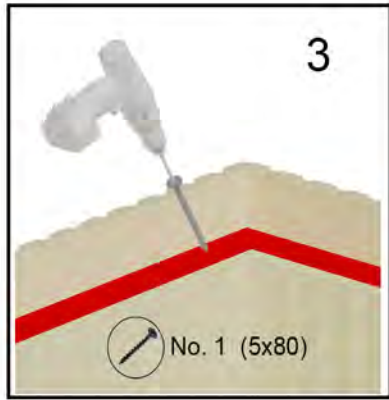
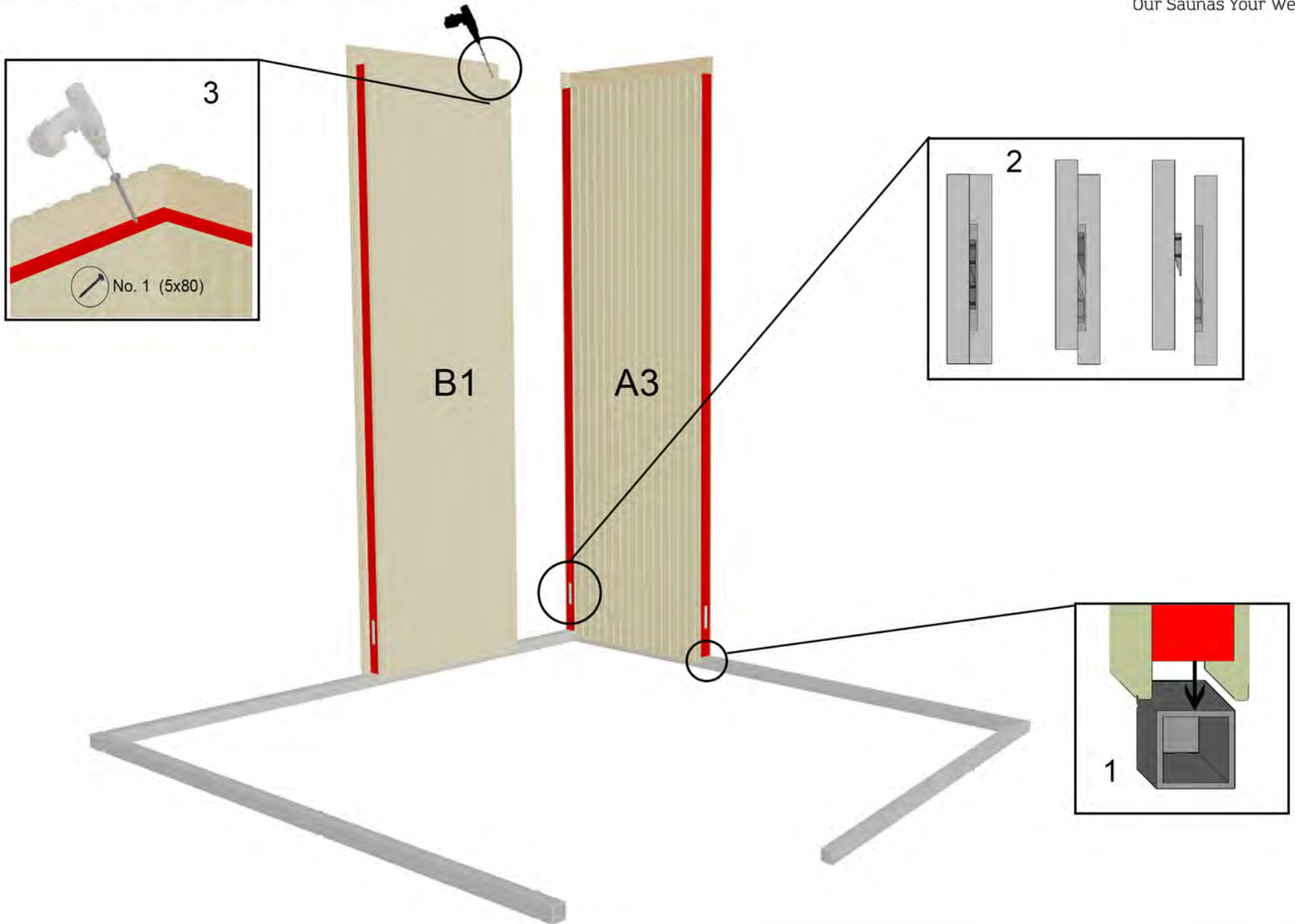

# 5. Fixing walls A1 & A2

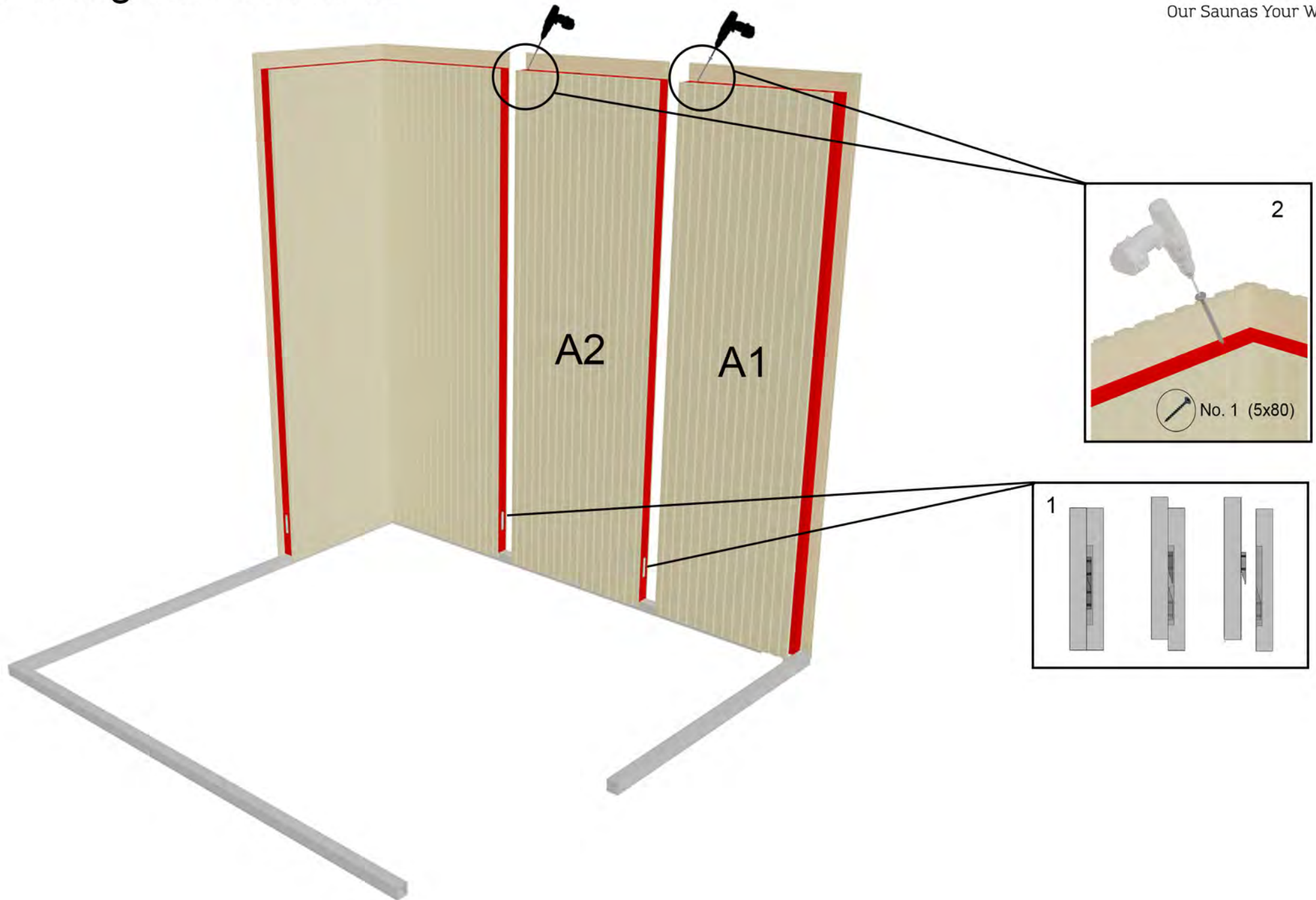

## 6. Fixing walls B2 & B3

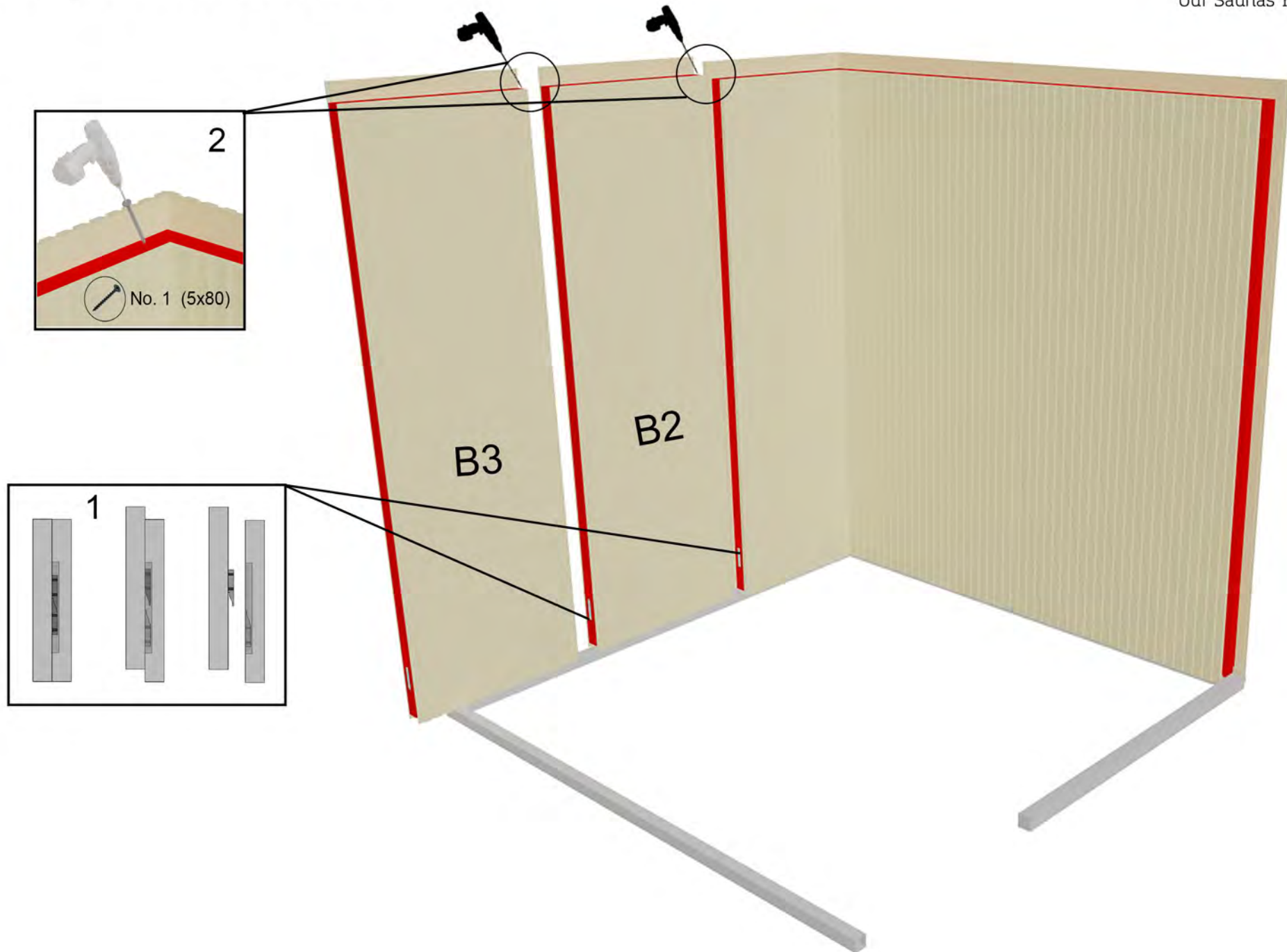

# 7. Fixing walls C1 & C2 & C3

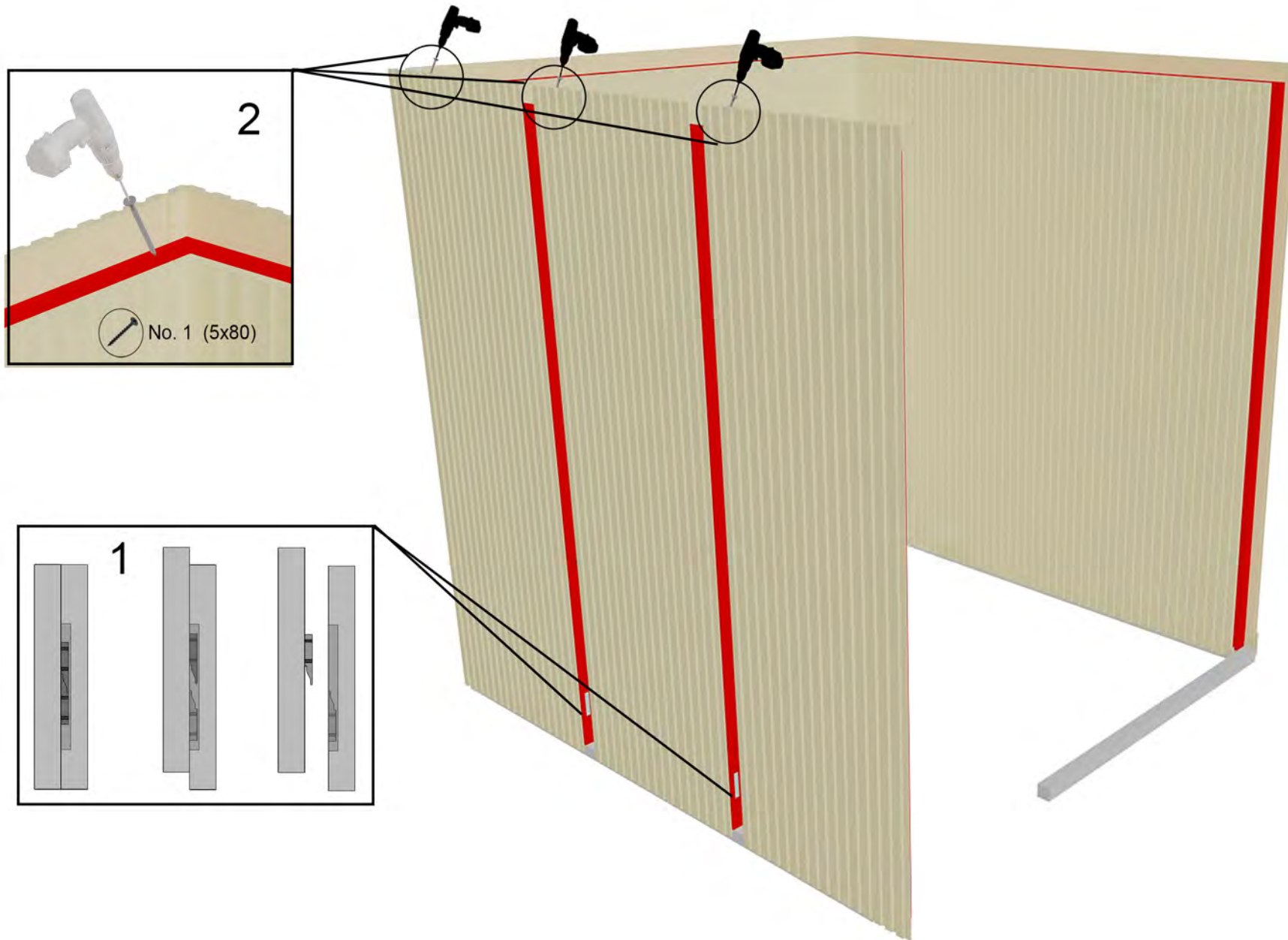

# 8. Fixing walls D1 & D2

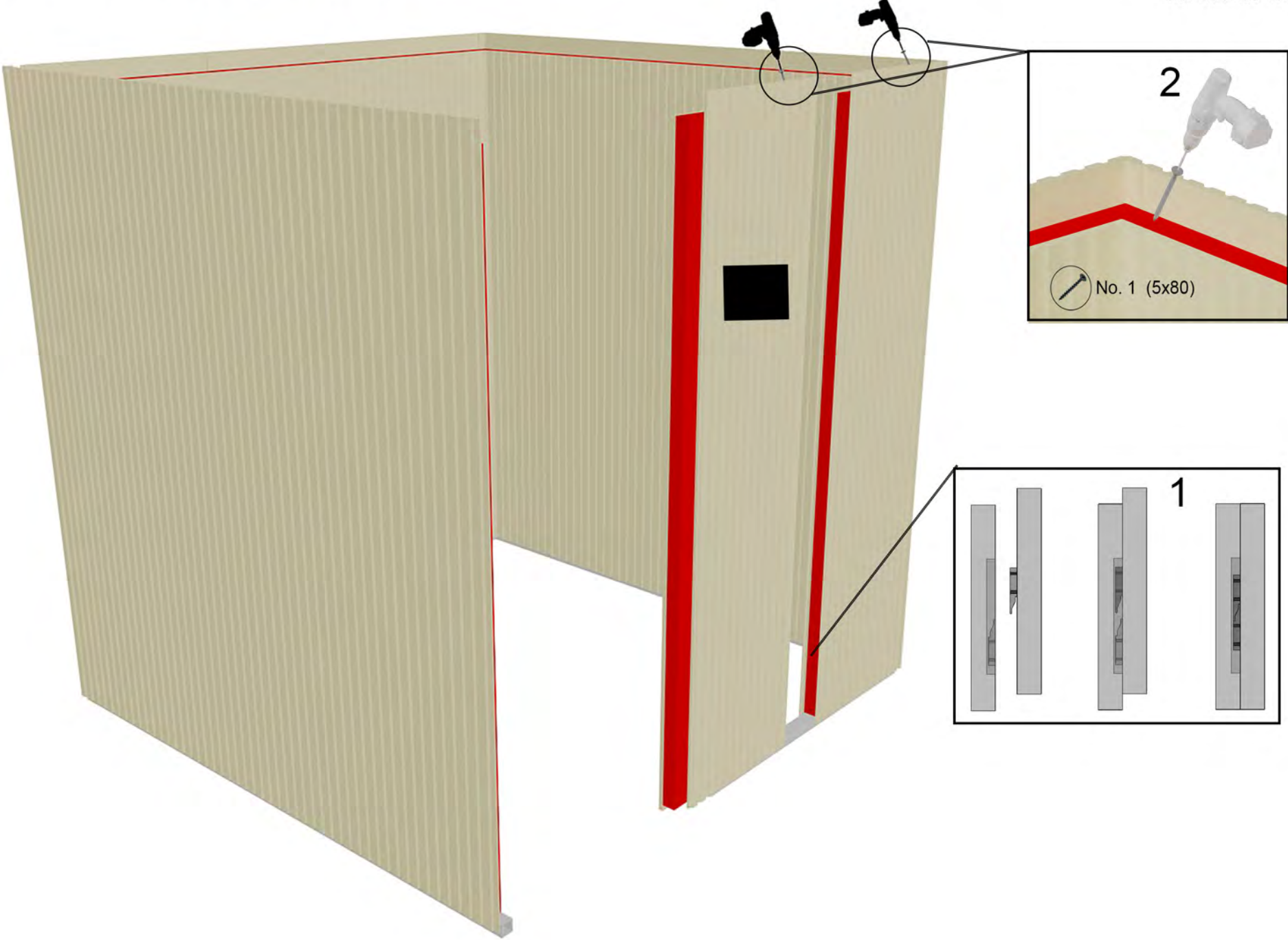

# 9. Fixing ceilings

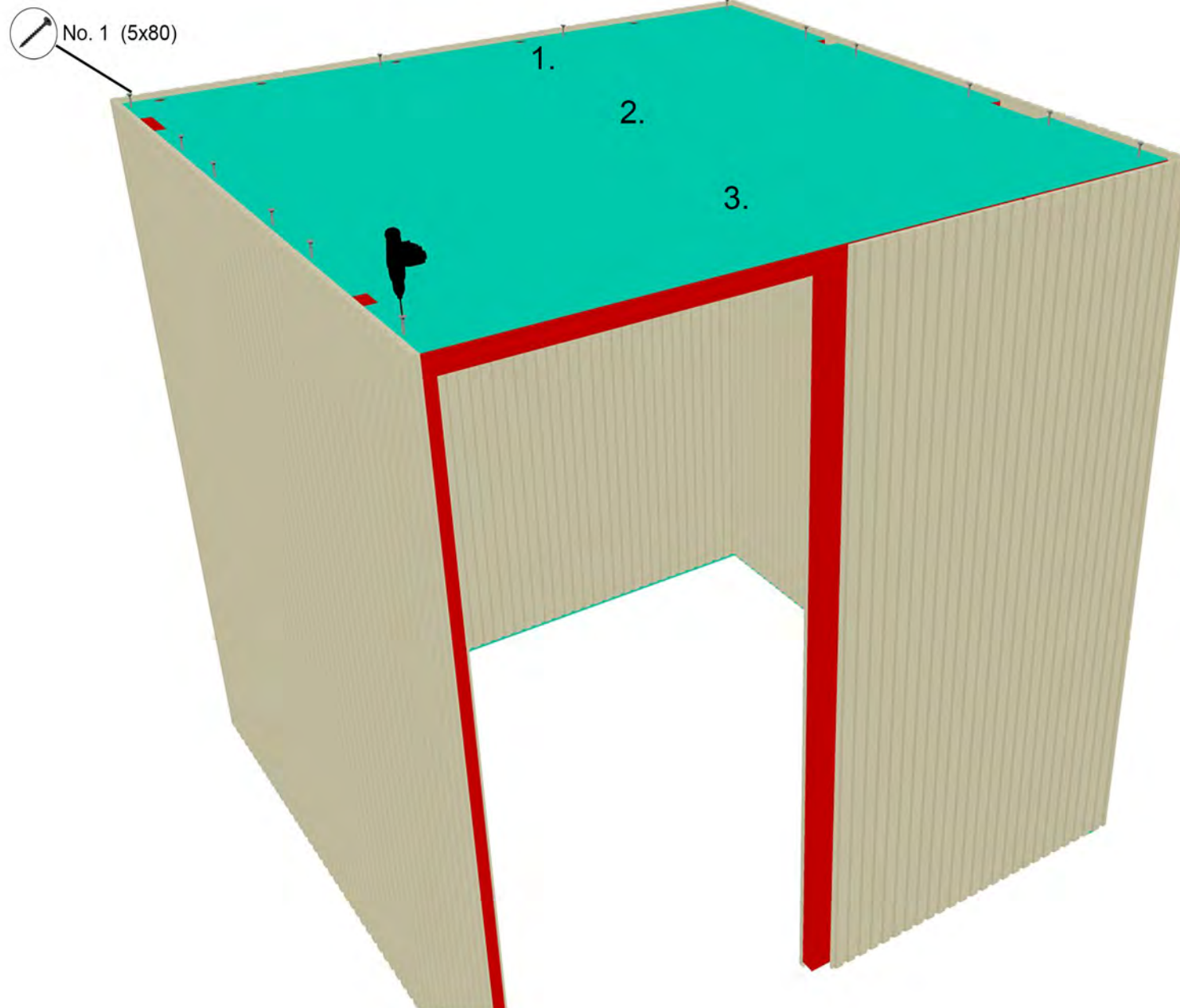

10. Interior  
150x180 cm  
150x200 cm  
200x200 cm

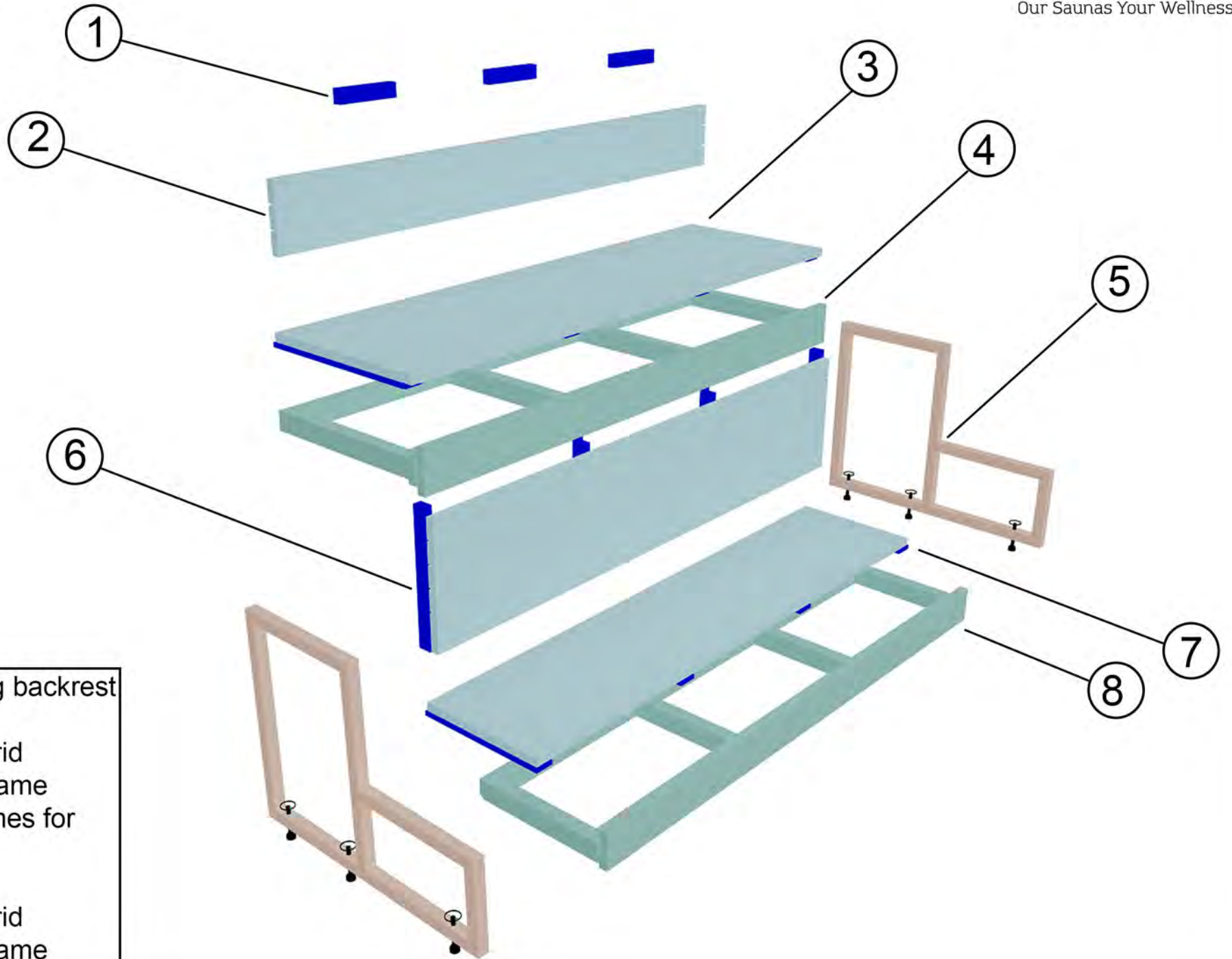

- 1. Blocks for fixing backrest
- 2. Backrest
- 3. Upper bench grid
- 4. Upper bench frame
- 5. Assistance frames for fixing benches
- 6. Bench skirt
- 7. Lower bench grid
- 8. Lower bench frame

# 10.1 Interior 120x180 cm

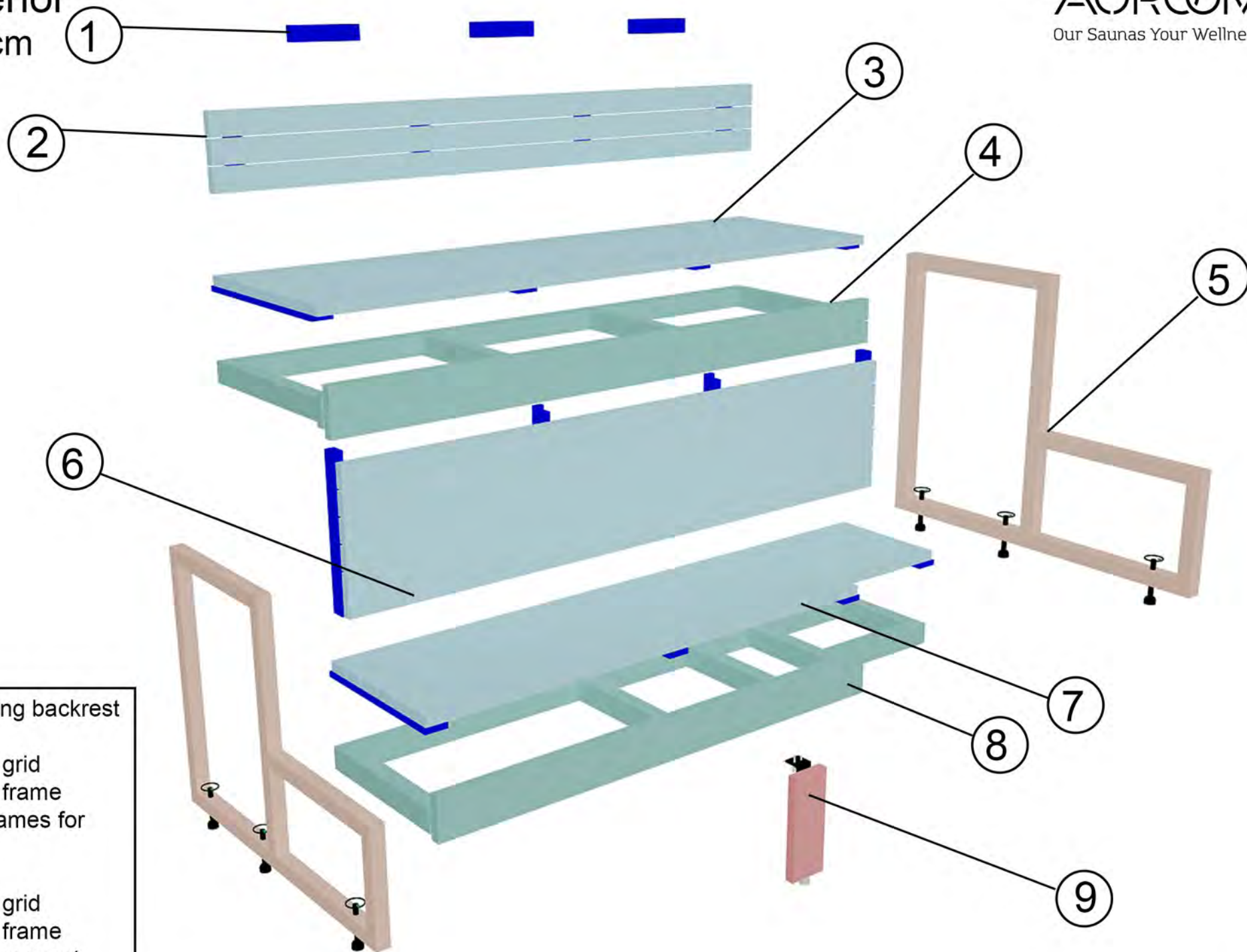

- 1. Blocks for fixing backrest
- 2. Backrest
- 3. Upper bench grid
- 4. Upper bench frame
- 5. Assistance frames for fixing benches
- 6. Bench skirt
- 7. Lower bench grid
- 8. Lower bench frame
- 9. Lower bench support

# 10.2 Interior 200x250 cm

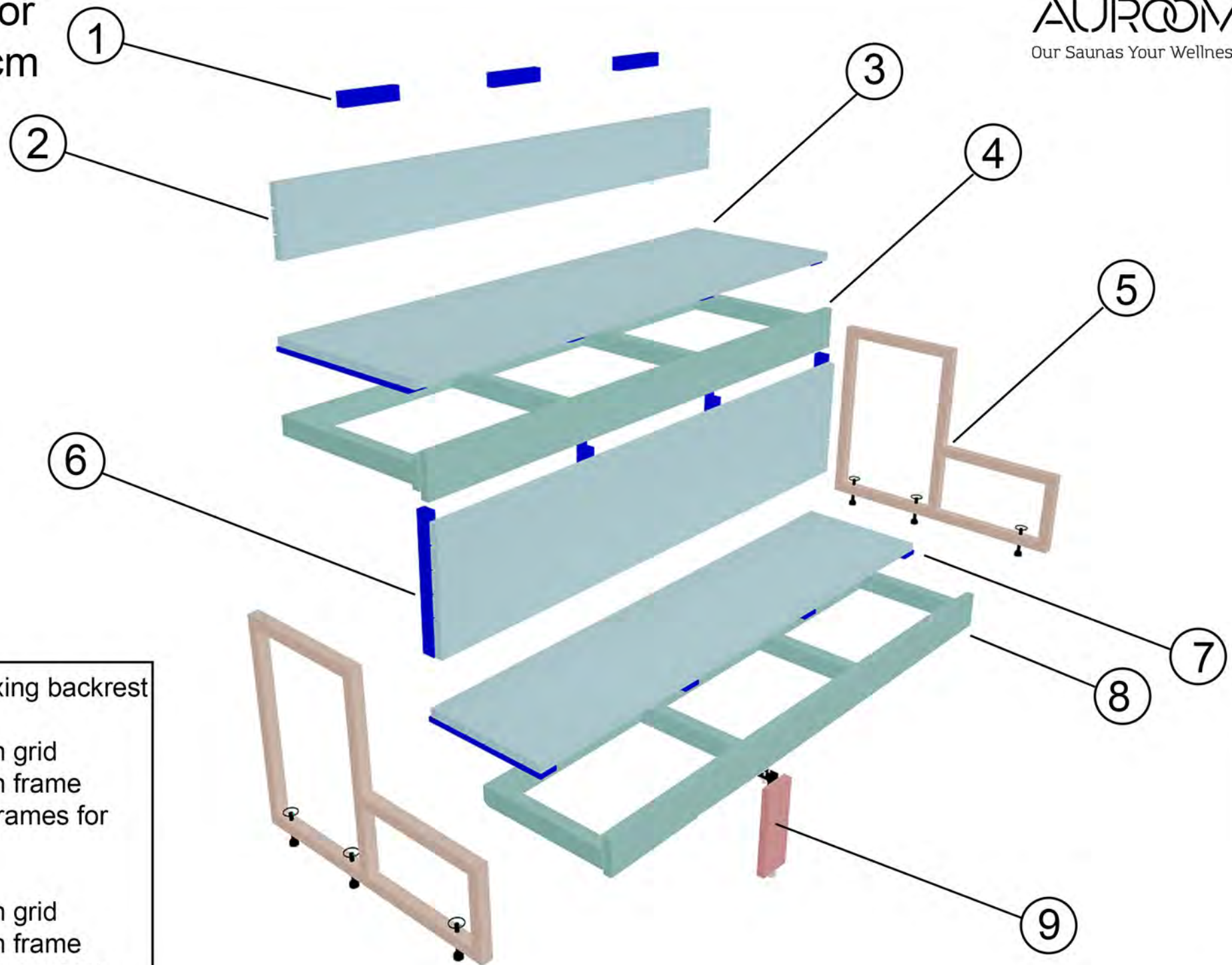

- 1. Blocks for fixing backrest
- 2. Backrest
- 3. Upper bench grid
- 4. Upper bench frame
- 5. Assistance frames for fixing benches
- 6. Bench skirt
- 7. Lower bench grid
- 8. Lower bench frame
- 9. Lower bench support

# 11. Assistance frames

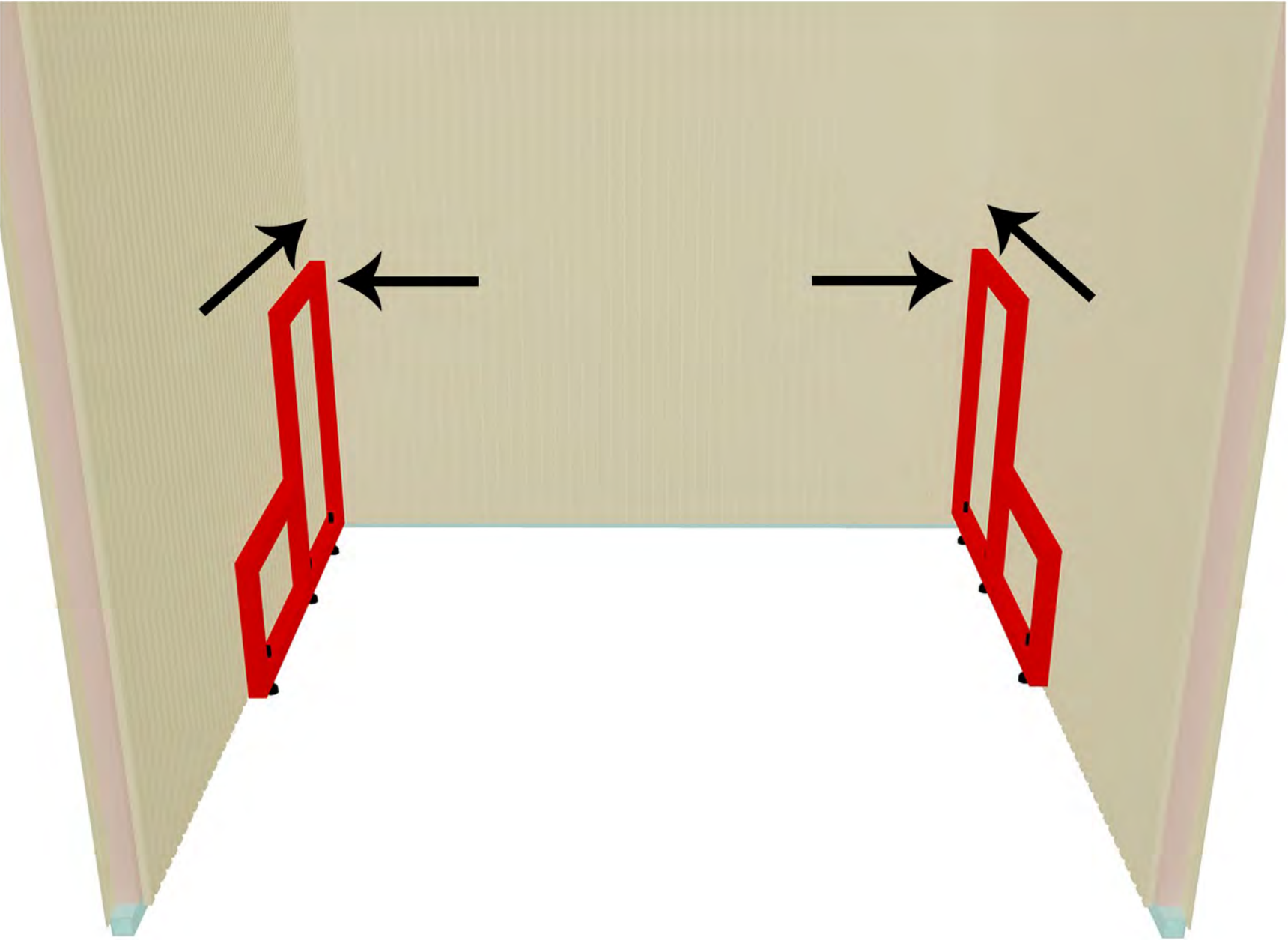

# 12. Bench support installing

120x180 cm

150x180 cm

150x200 cm

200x250 cm

Pre-marked stripes

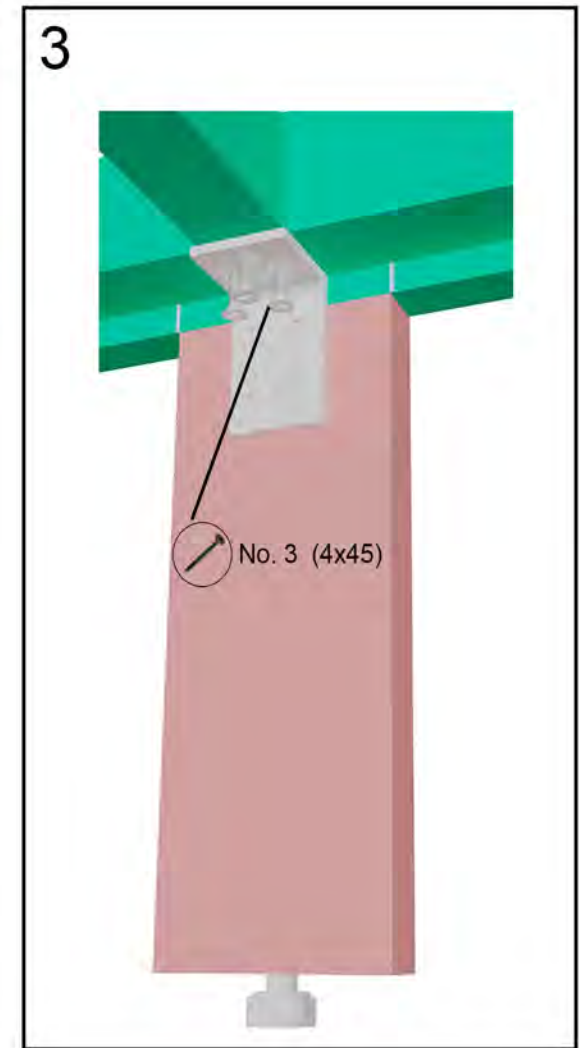
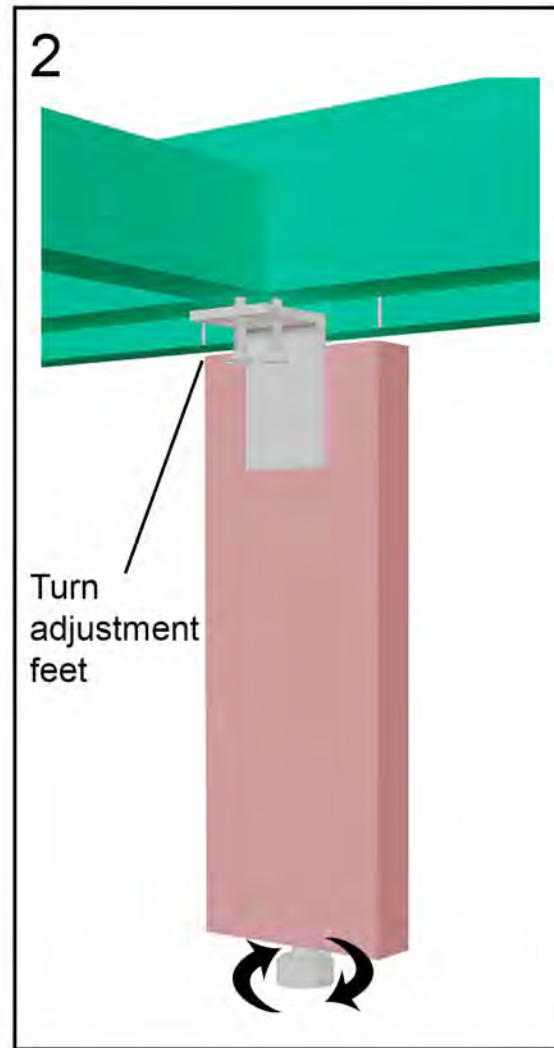
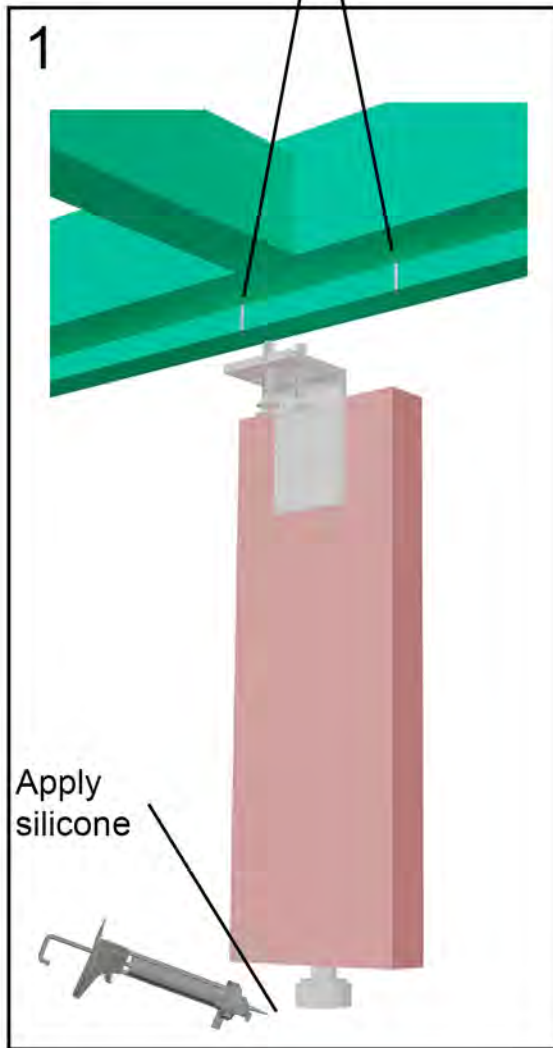

# 13. Bench frames and backrest blocks fixing

150x180 cm

150x200 cm

200x200 cm

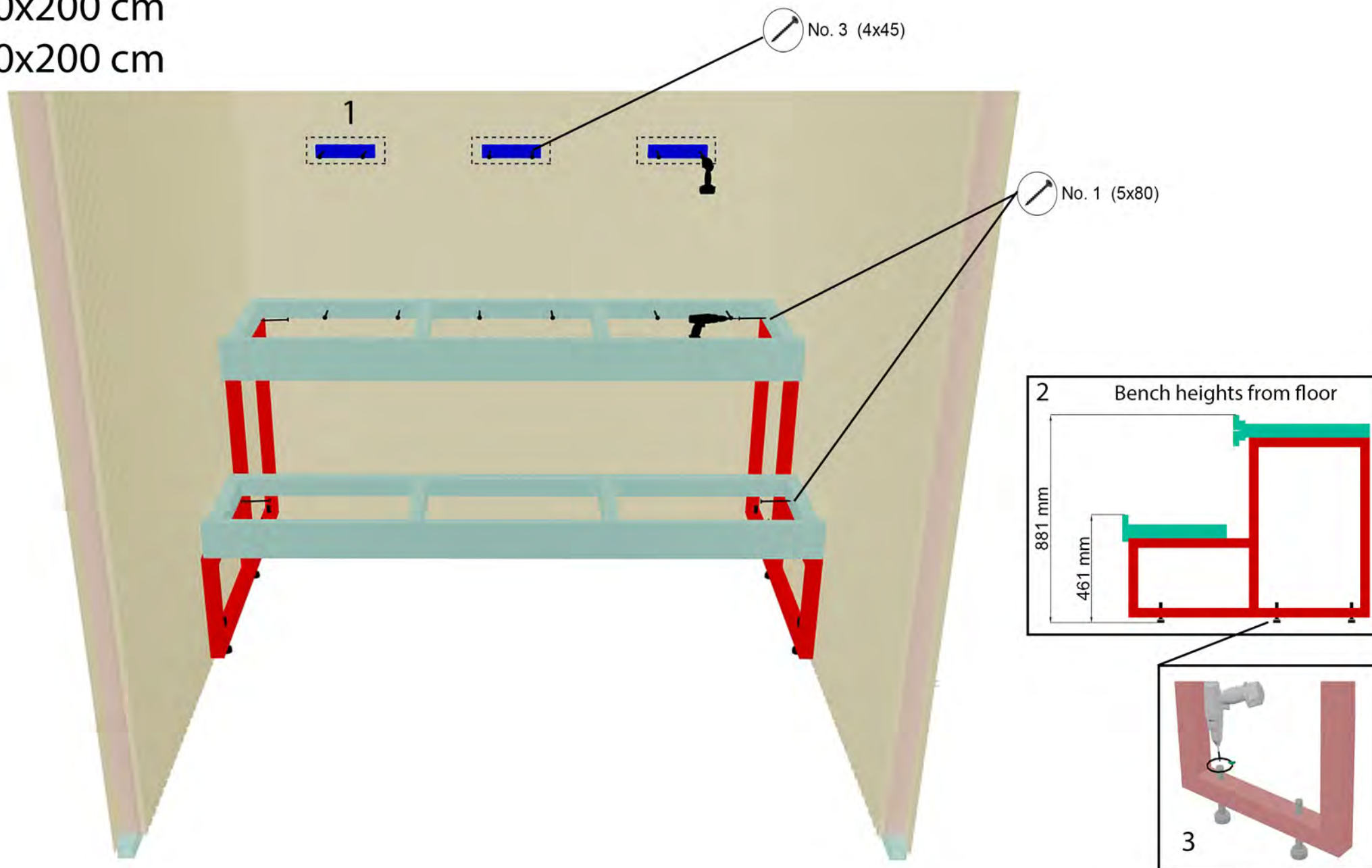

# 13.1 Bench frames and backrest blocks fixing 120x180 cm

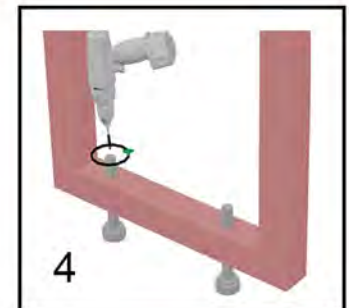
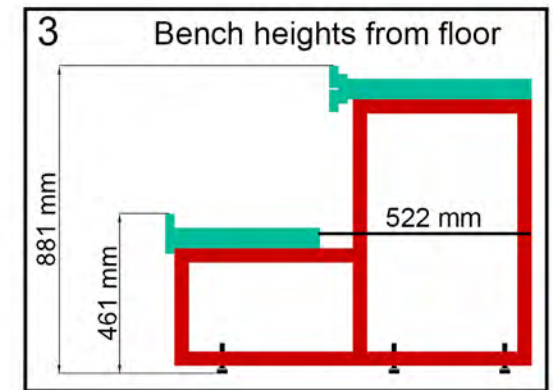
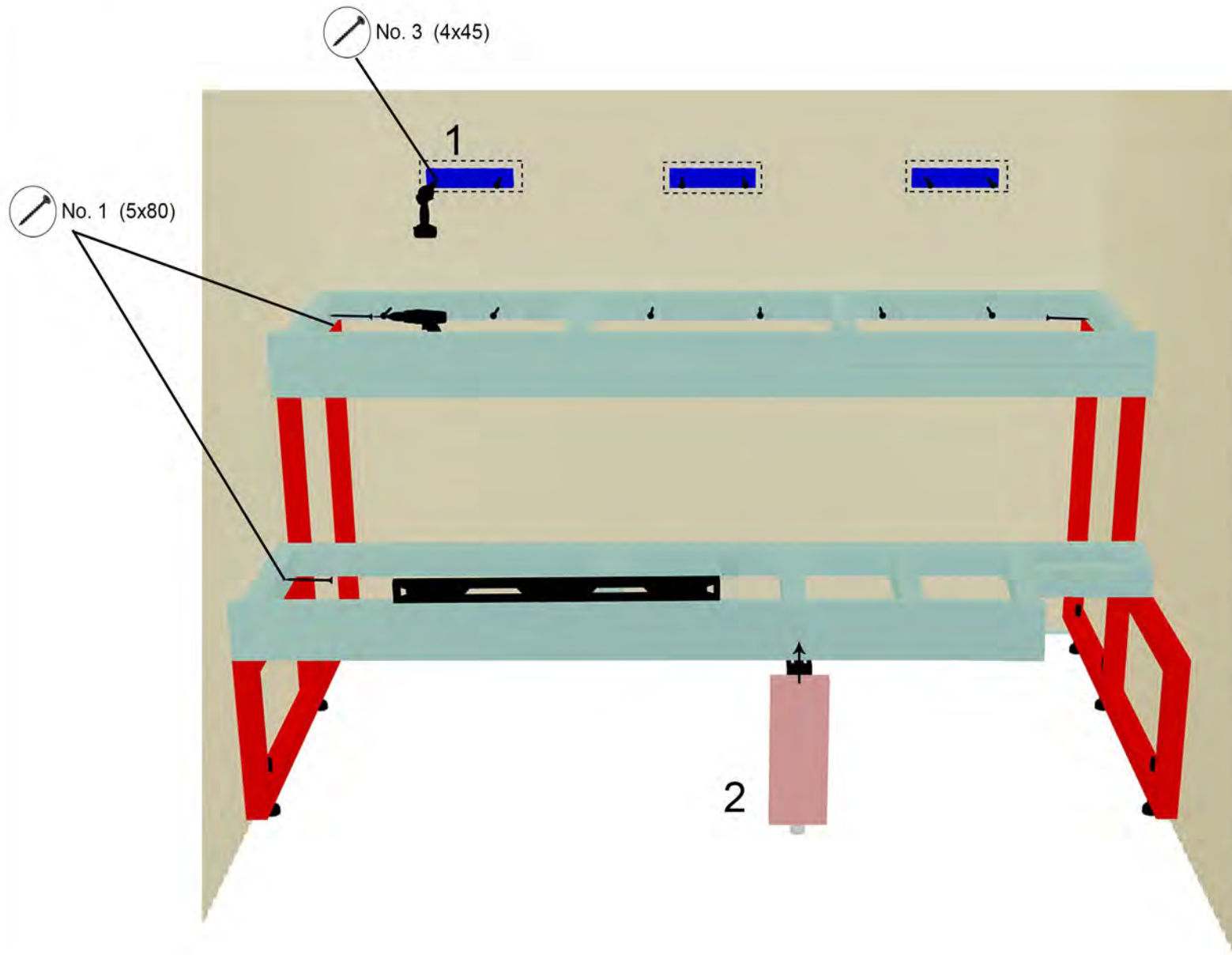

# 13.2 Bench frames and backrest blocks fixing 200x250 cm

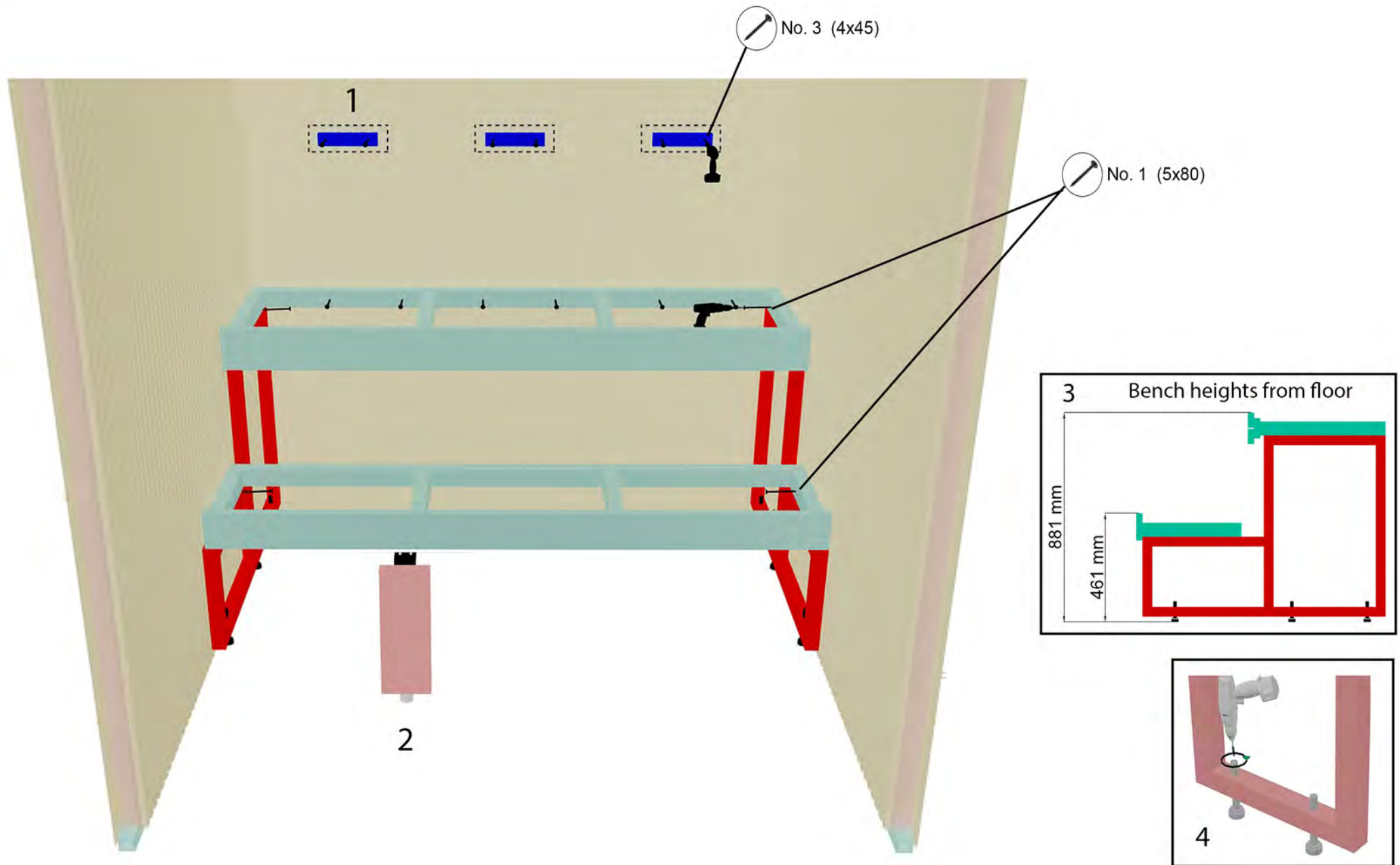

# 14. Removing assistance frames

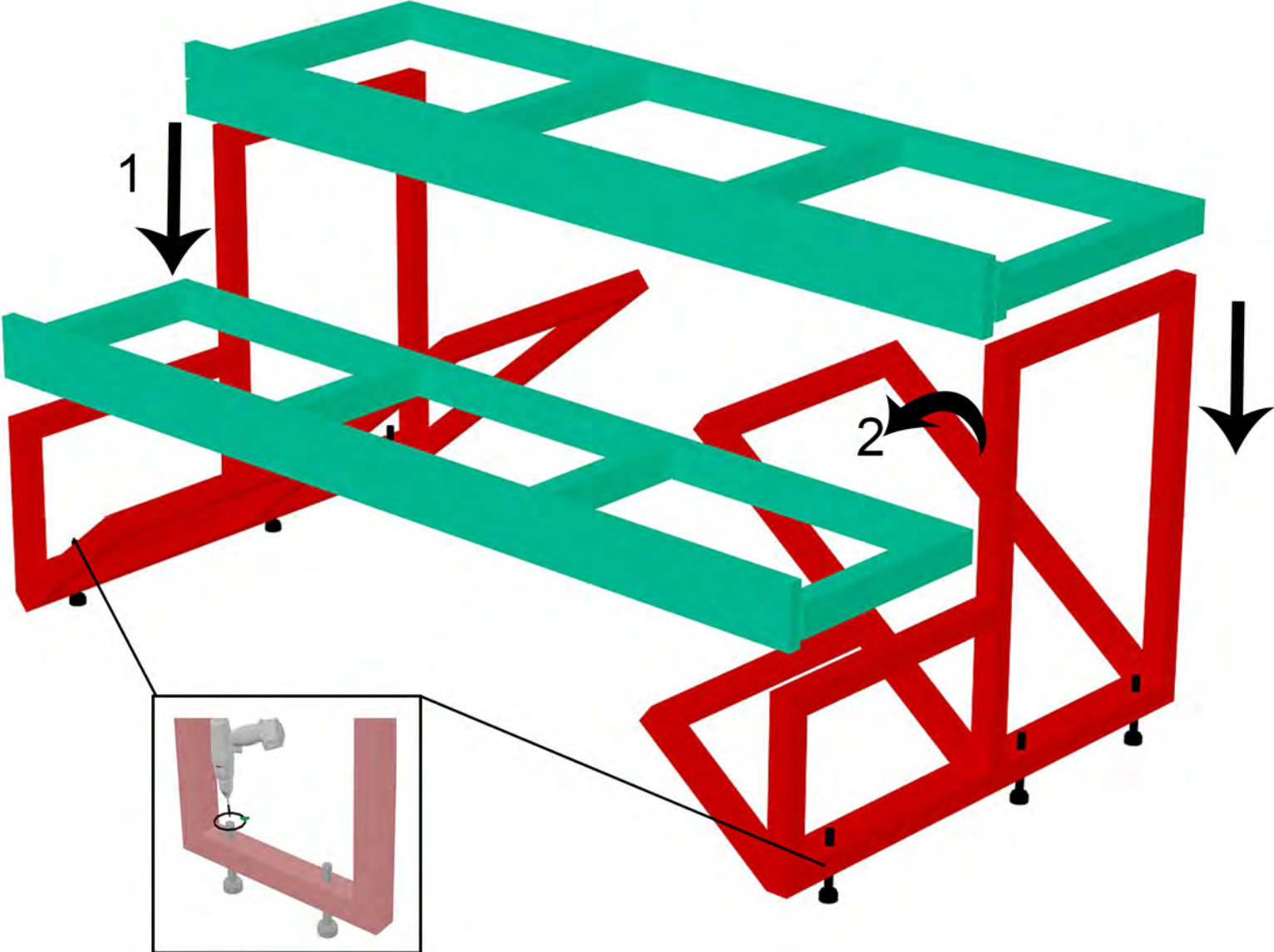

# 15. Wiring inside walls



1. Push down wires from precut holes on ceiling

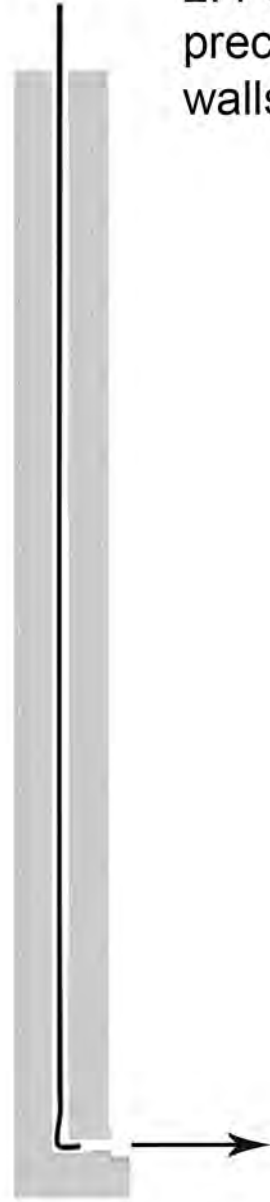

2. Pull out wires from precut holes in the walls

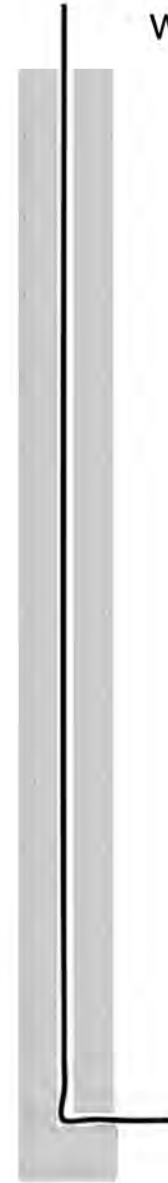

3. Connect wires

# 16. Connecting LED-strips

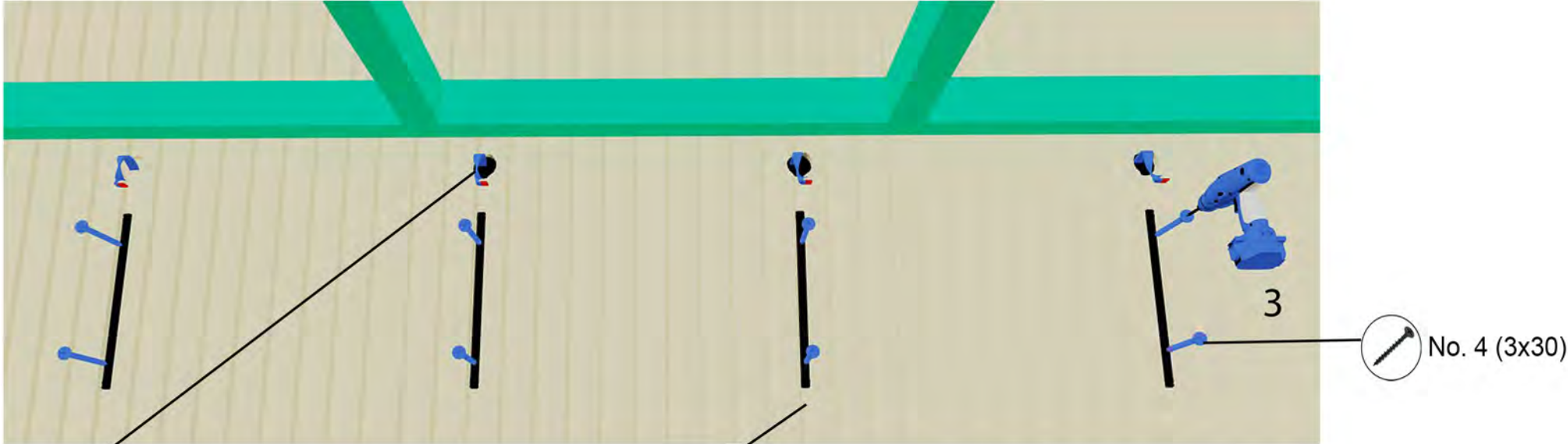

**!** Always use certified electrician

# 17. Fixing bench skirt

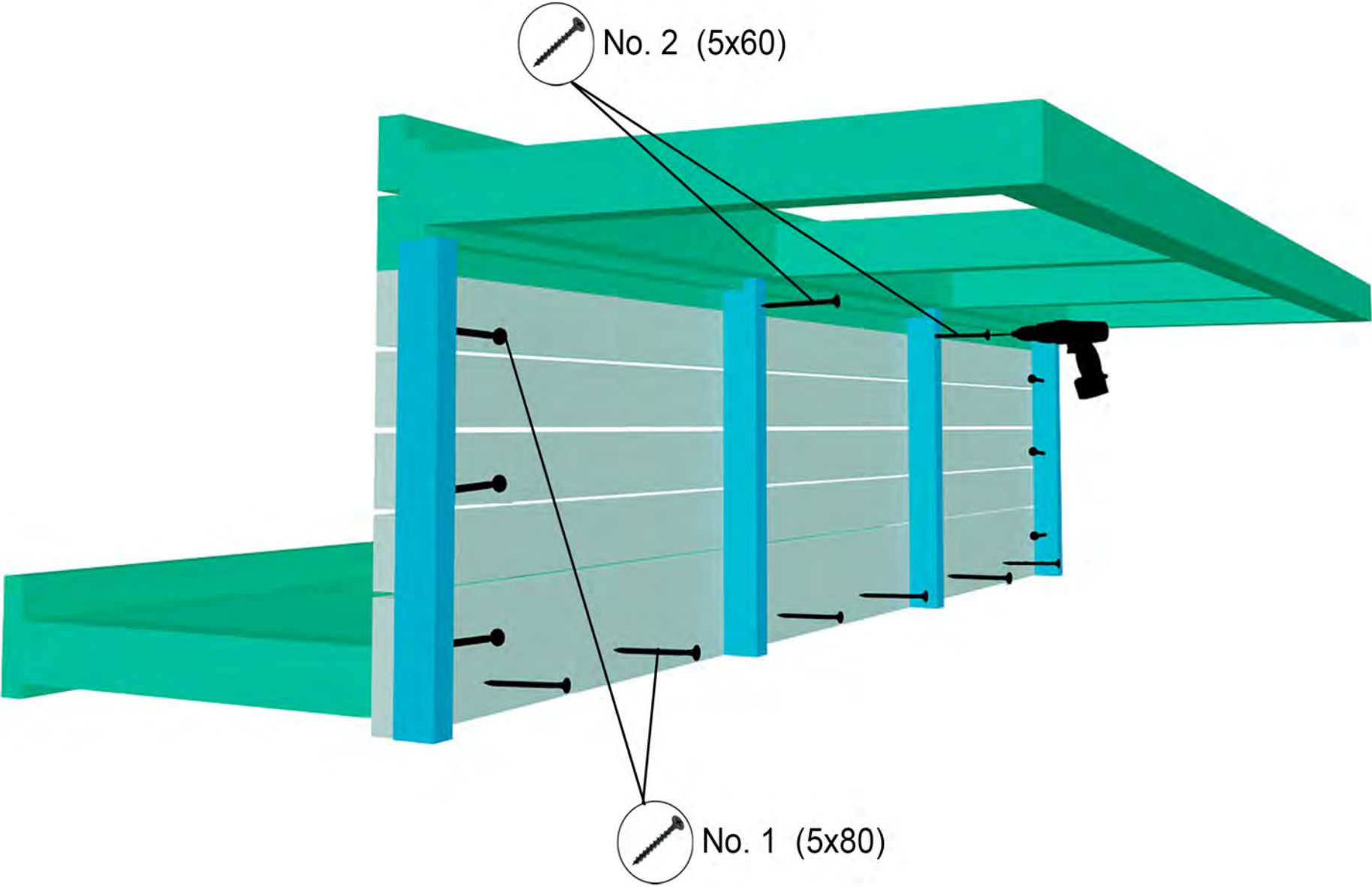

# 18. Backrest & bench grids

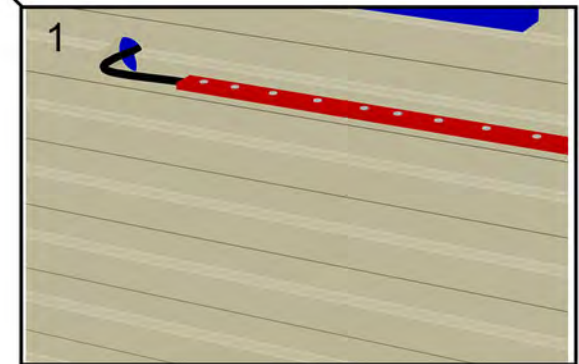
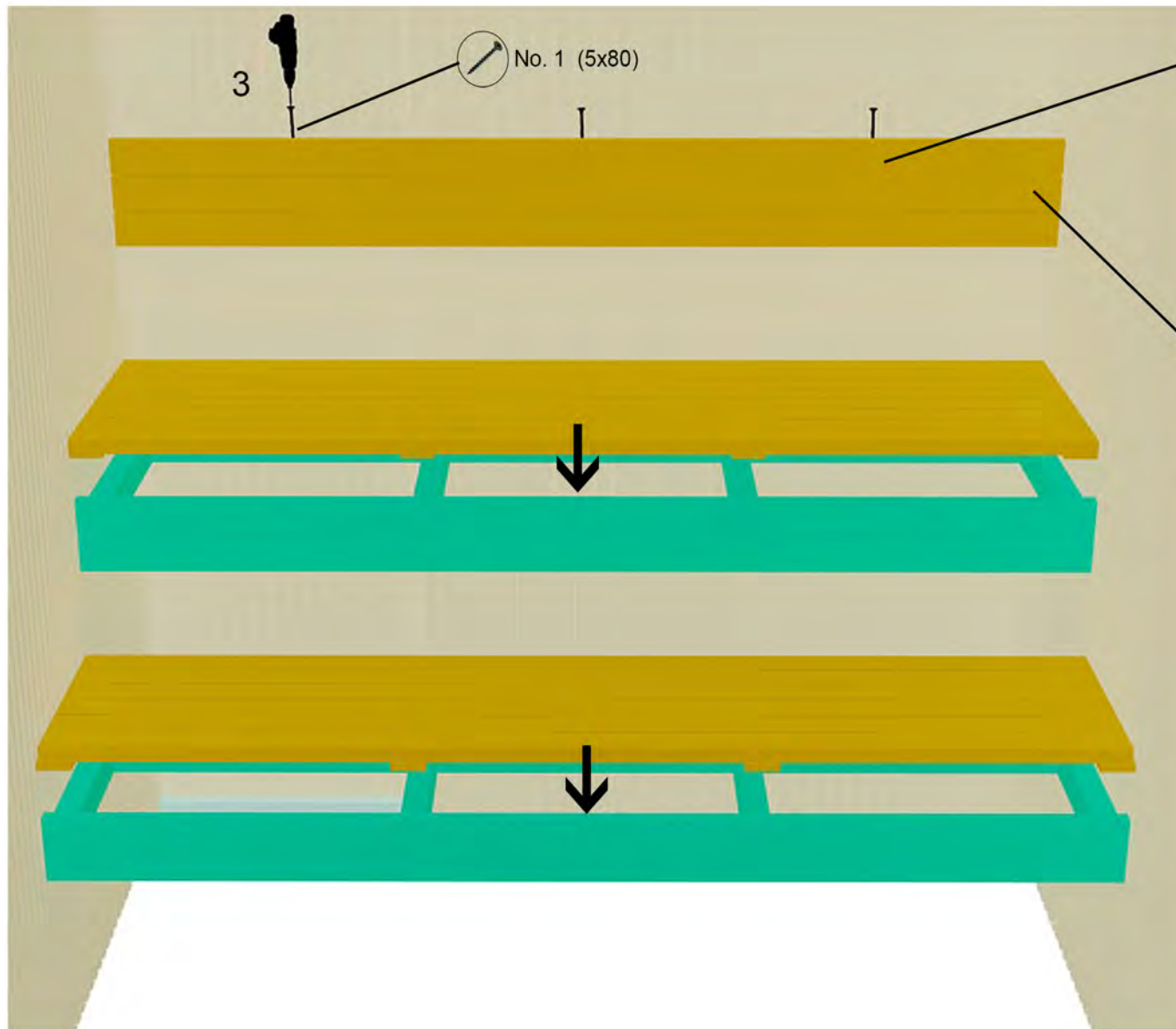

- 1. Push LED-strip cable to ceiling for connection
- 4. Fix LED-strip on top of backrest with glue (covering screws)

# 19. Interior II

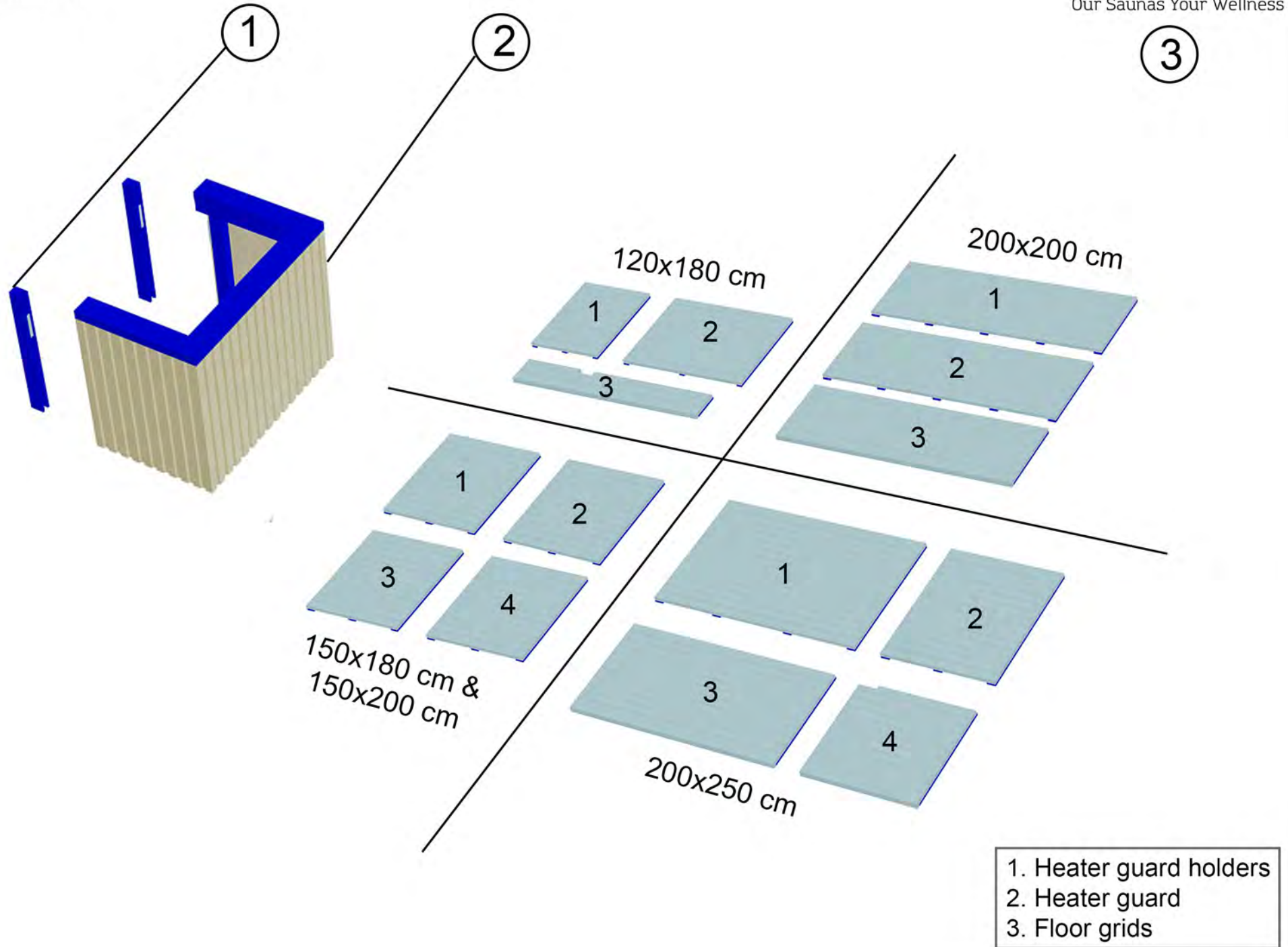

# 20. Heater guard

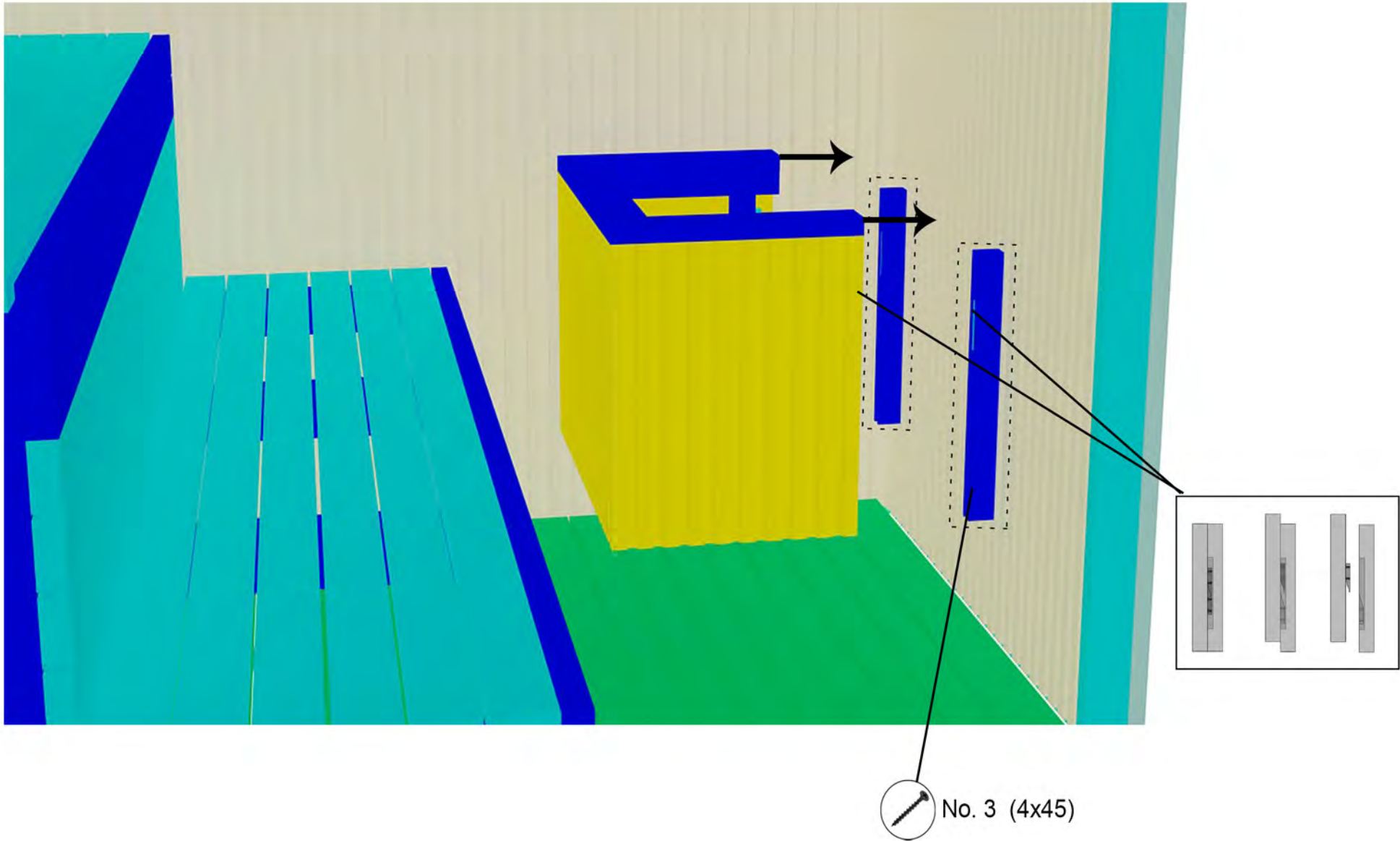

# 21. Door frames

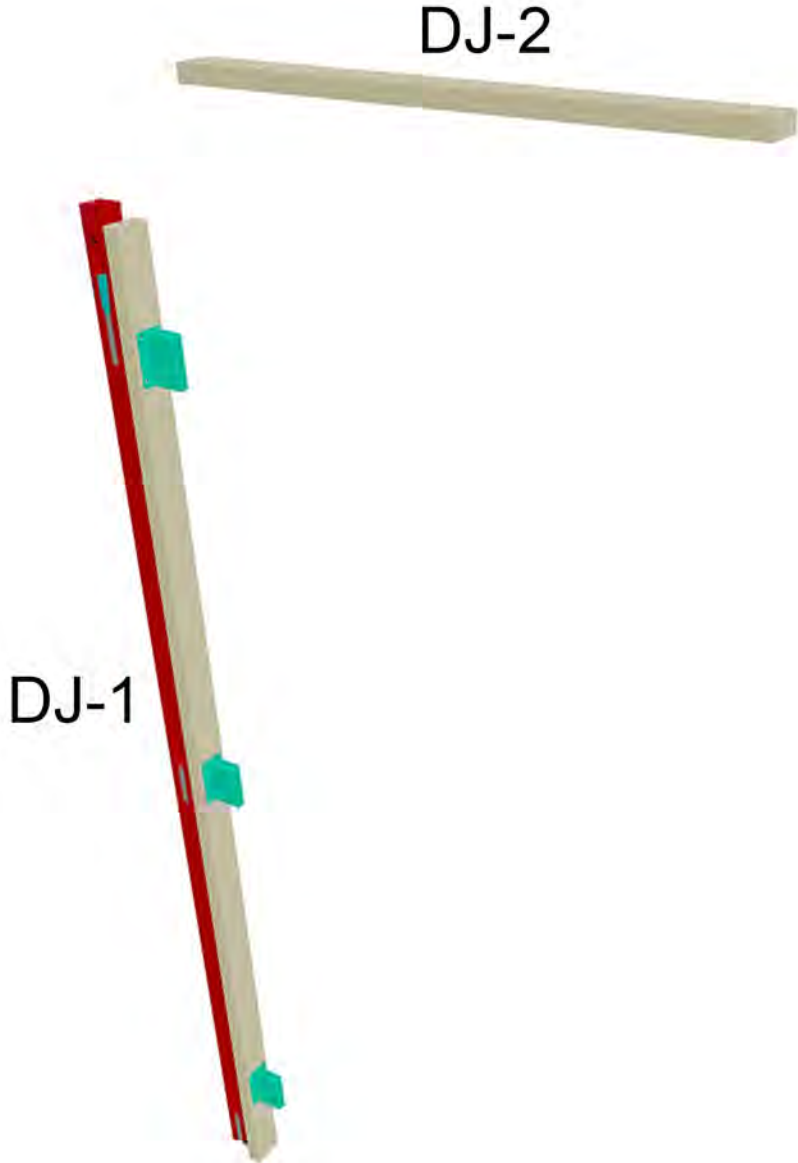

## 22. Fixing door frames

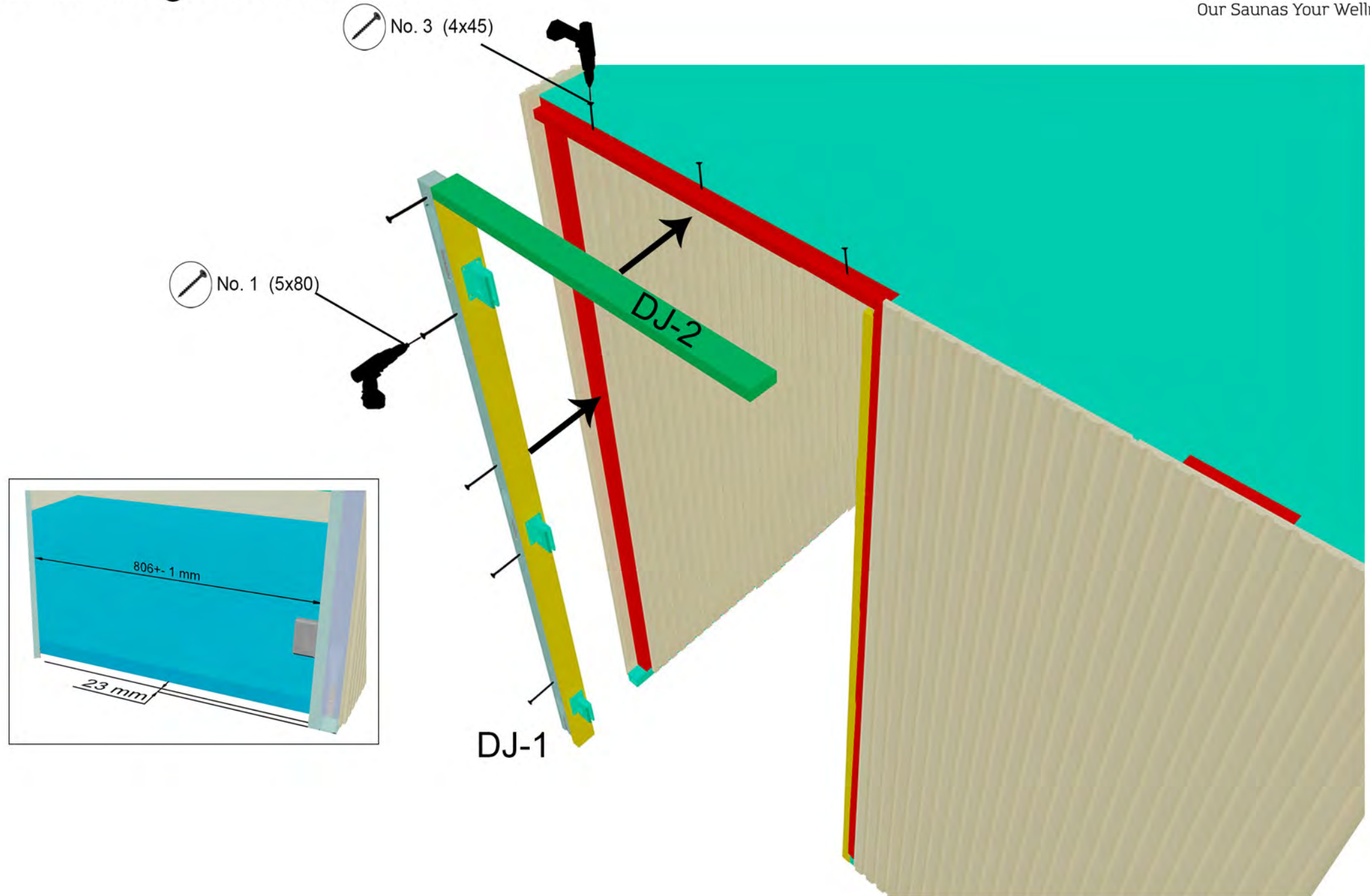

# 23. Front frame

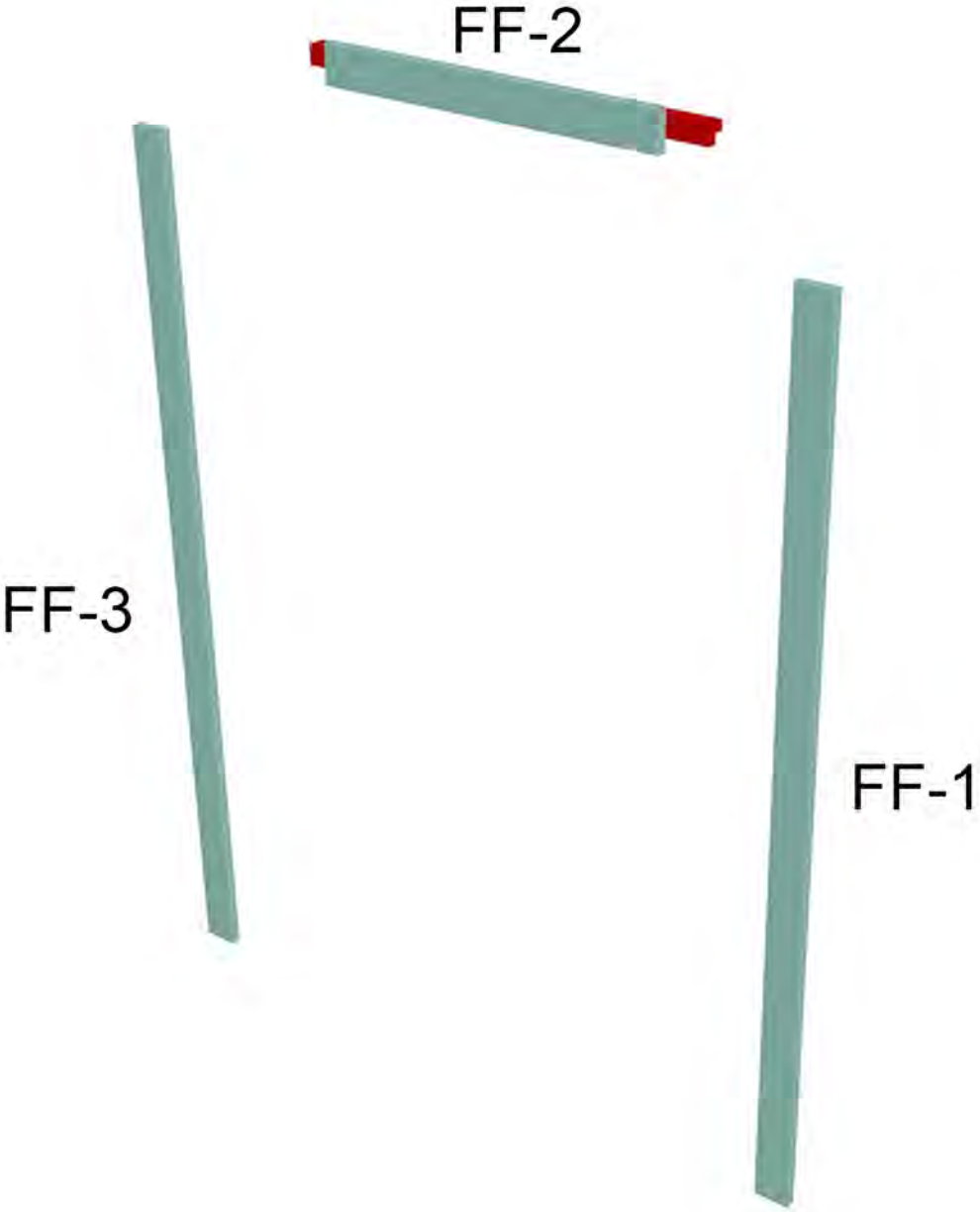

# 24. Fixing front frame

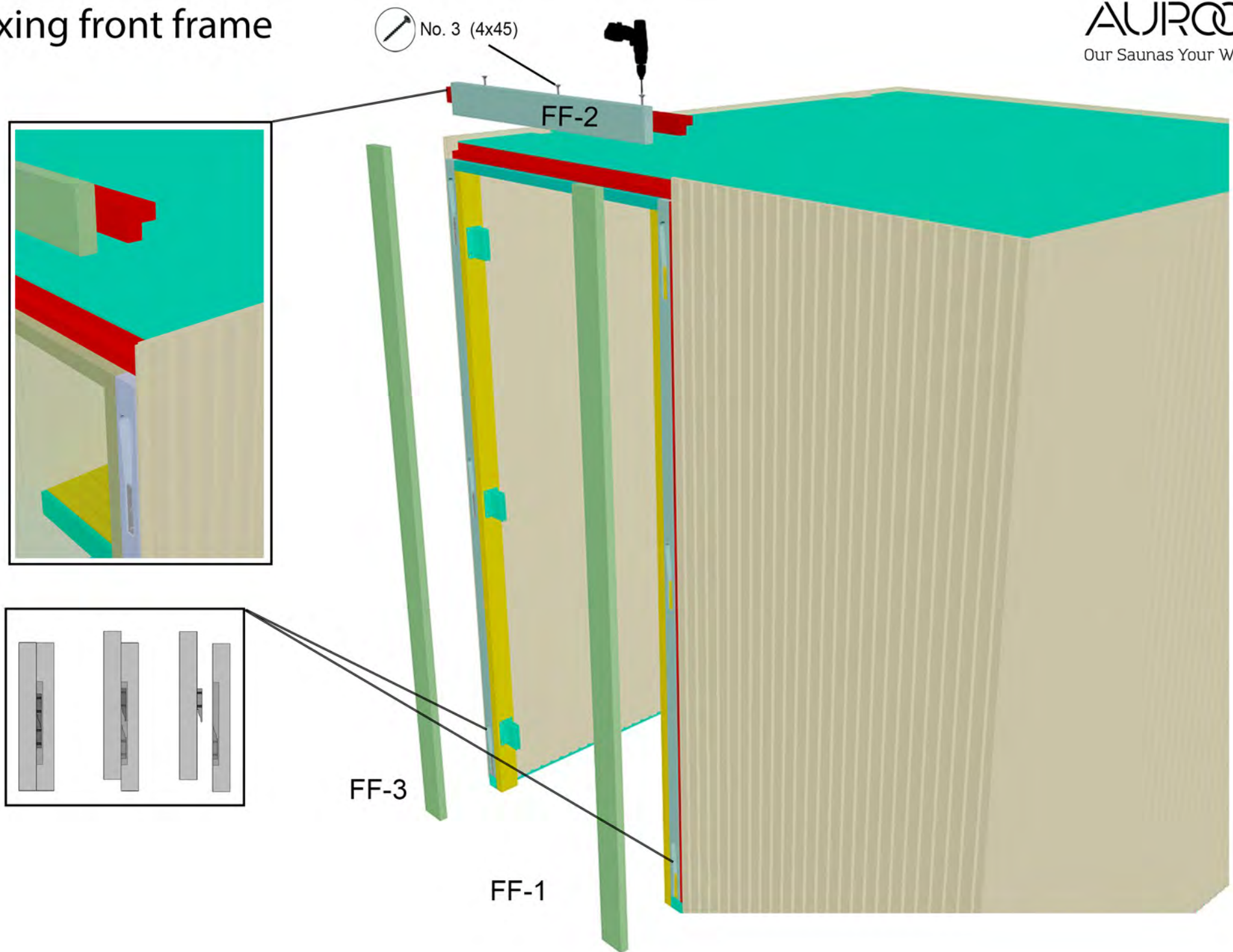

# 25. Door hinges and handle

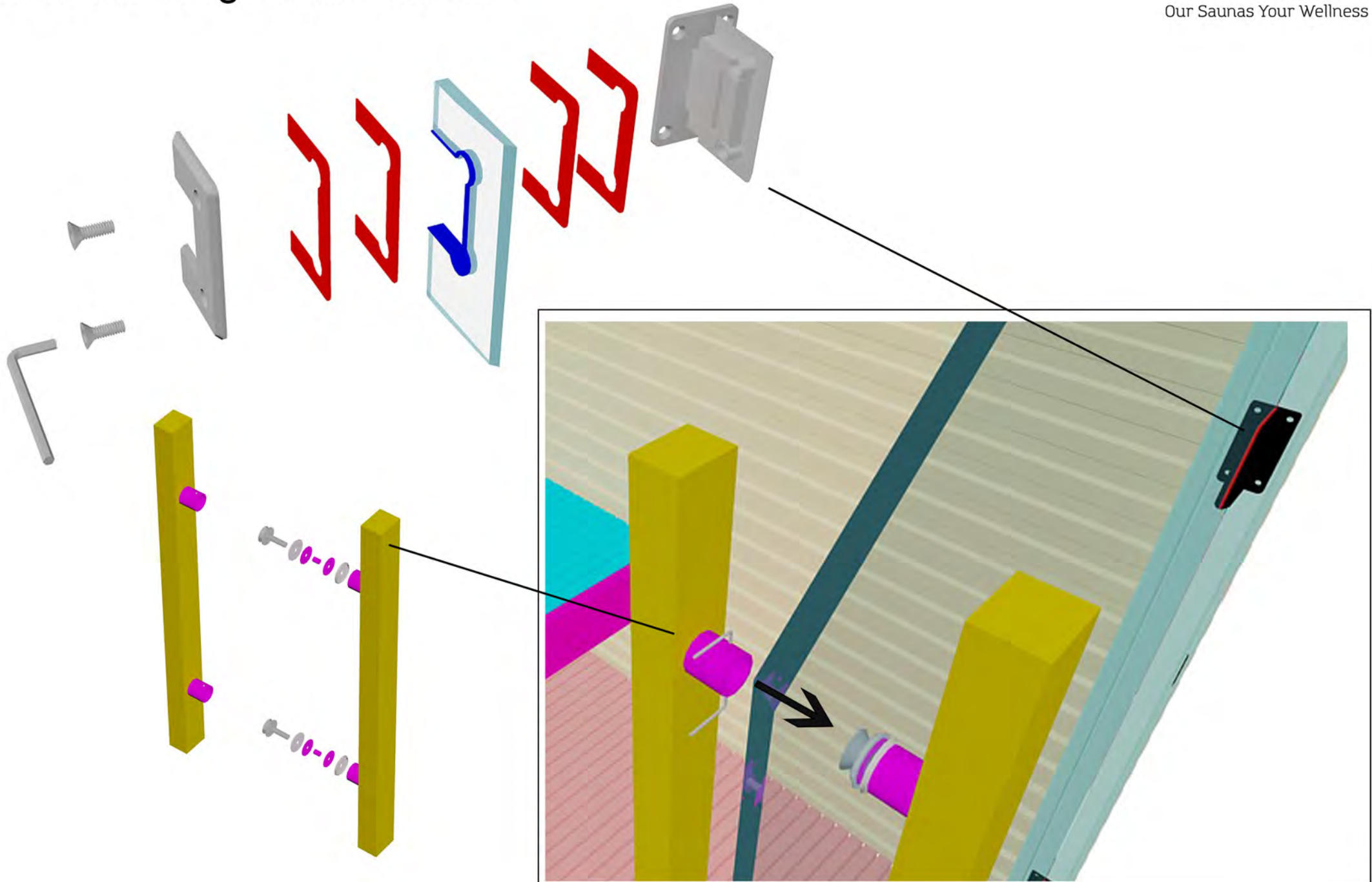

## 26. Wiring on ceiling

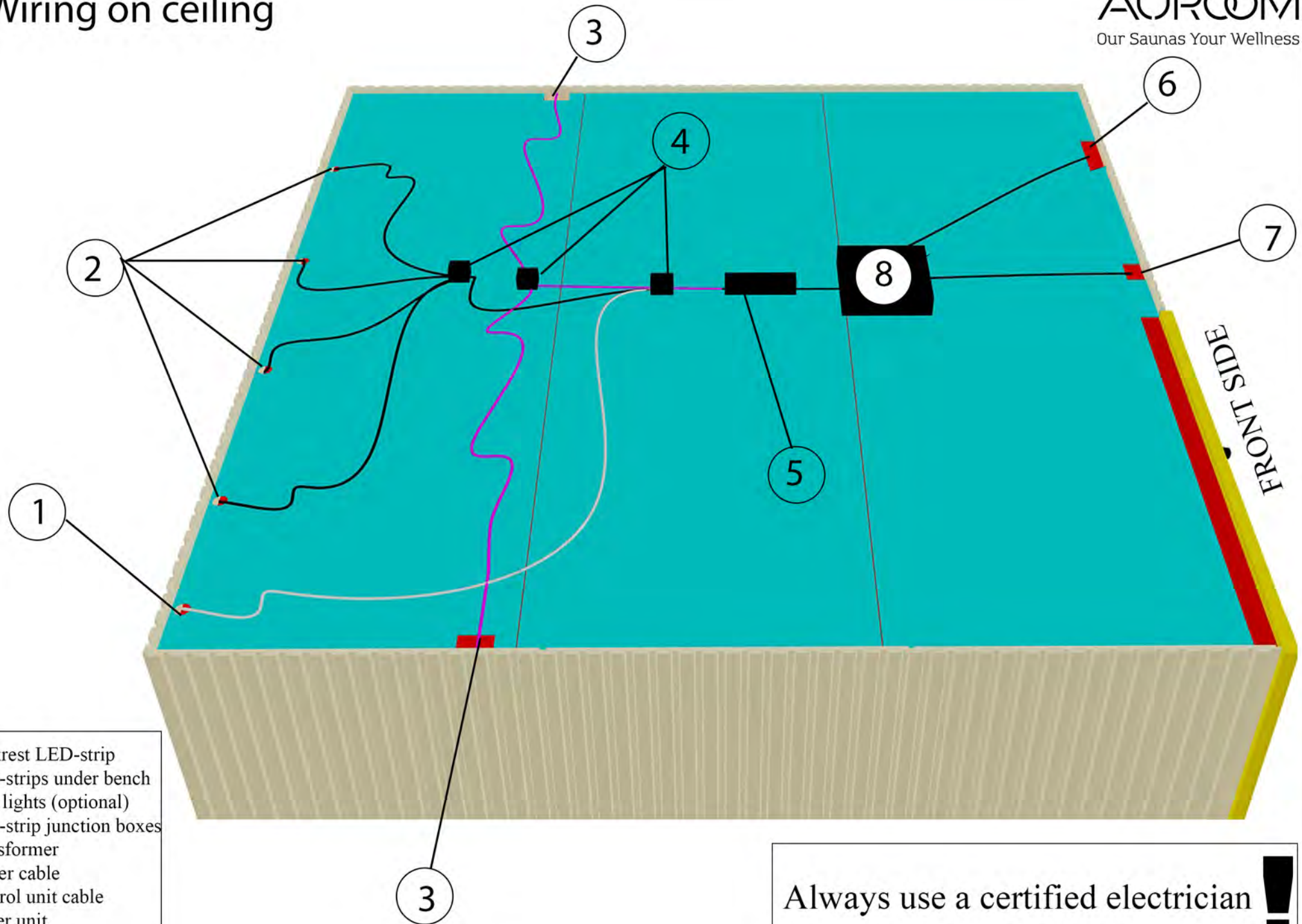

1. Backrest LED-strip
2. LED-strips under bench
3. Wall lights (optional)
4. LED-strip junction boxes
5. Transformer
6. Heater cable
7. Control unit cable
8. Power unit

Always use a certified electrician !

## LIBERA

### Installation manual

Dimensions:

120x180 cm

150x180 cm

150x200 cm

200x200 cm

200x250 cm

Handedness:

Right

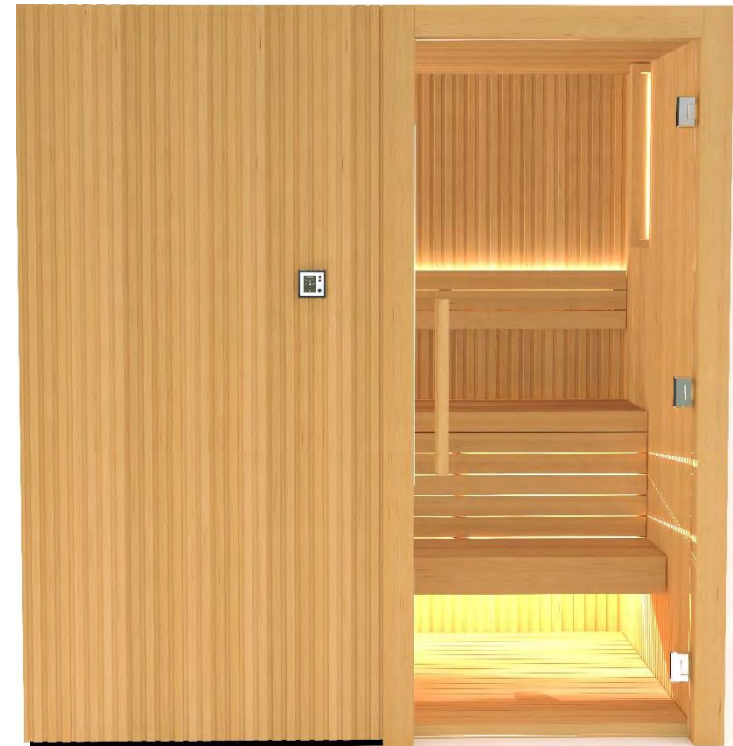

# Leave space for better assembly

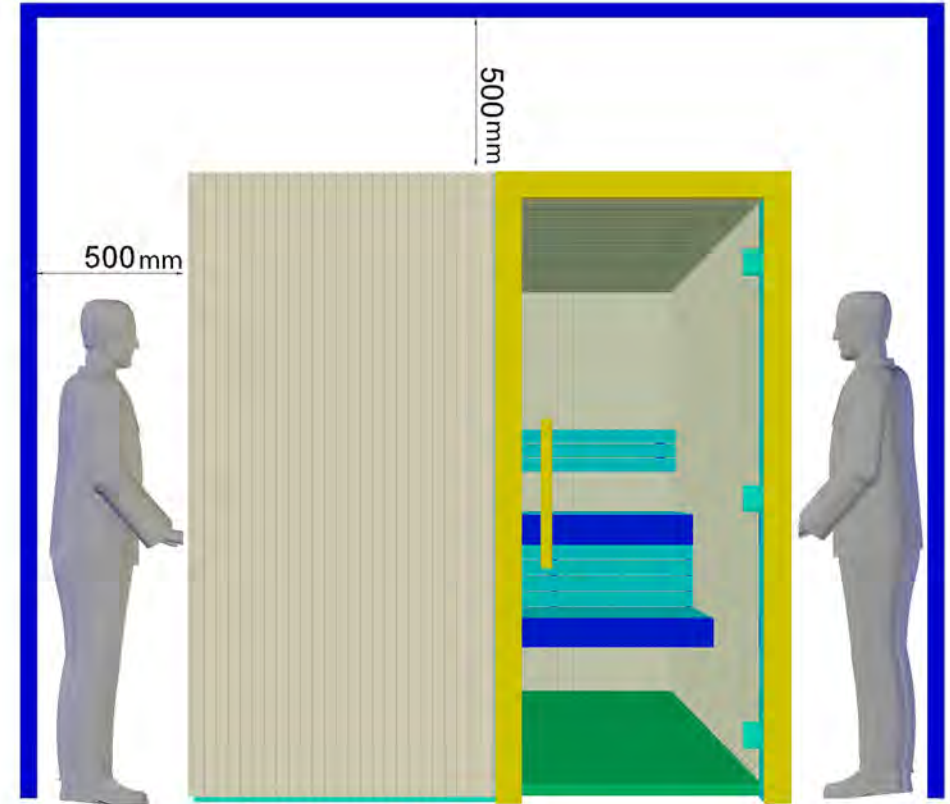
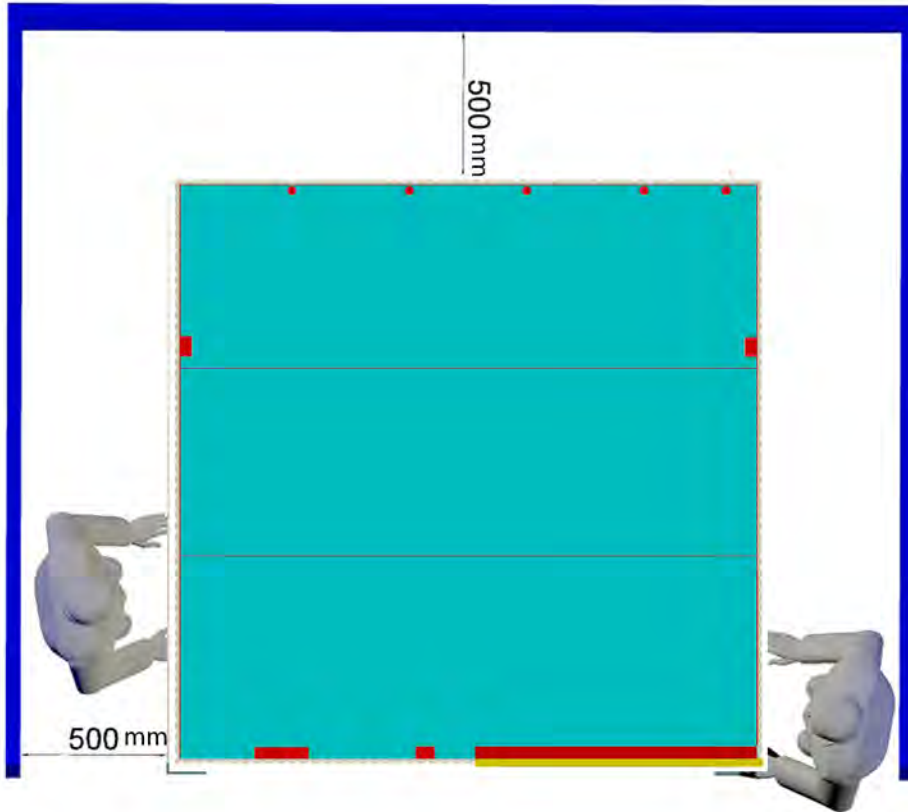

# Tools



# 1. Base frame

	x (mm)	y (mm)
120x180 cm	2115	1770
150x180 cm	2293	1770
150x200 cm	2451	1970
200x200 cm	2778	1970
200x250 cm	3152	2470

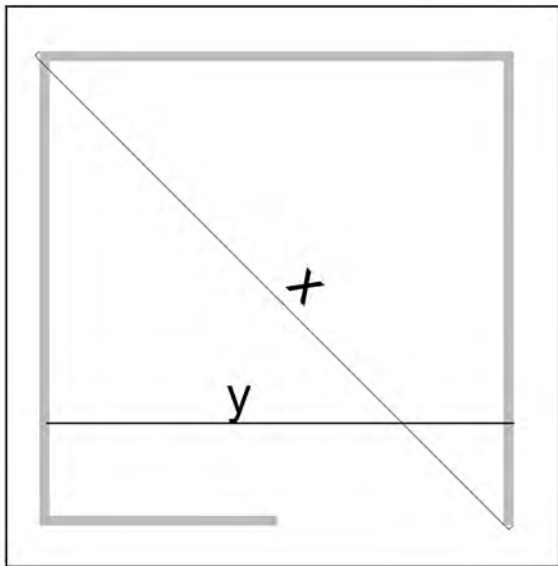
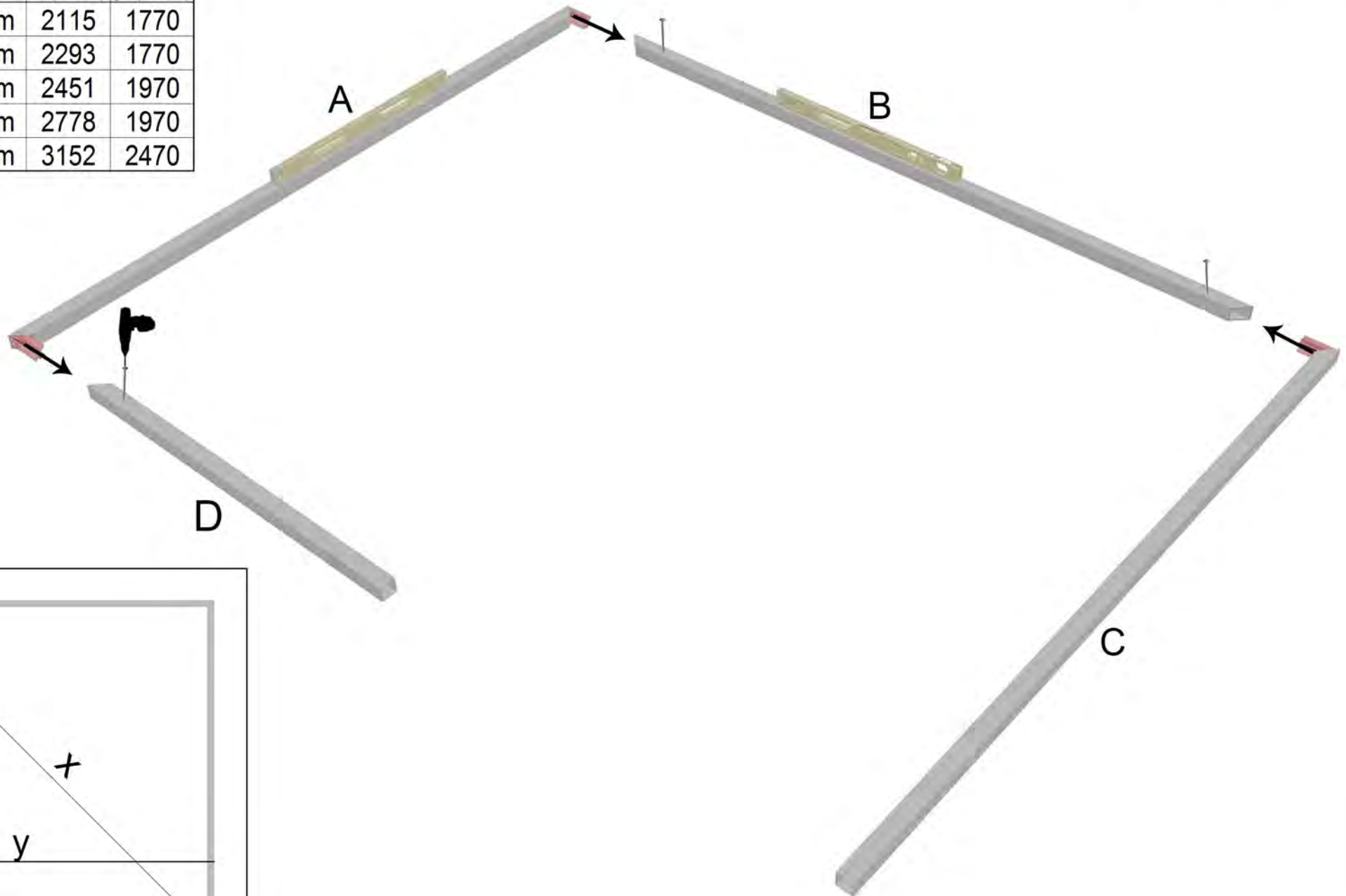

## 2. Walls

	Number of wall elements			
	A	B	C	D
120x180 cm	2	3	2	2
150x180 cm	2	3	2	2
150x200 cm	2	3	2	2
200x200 cm	3	3	3	2
200x250 cm	3	4	3	3

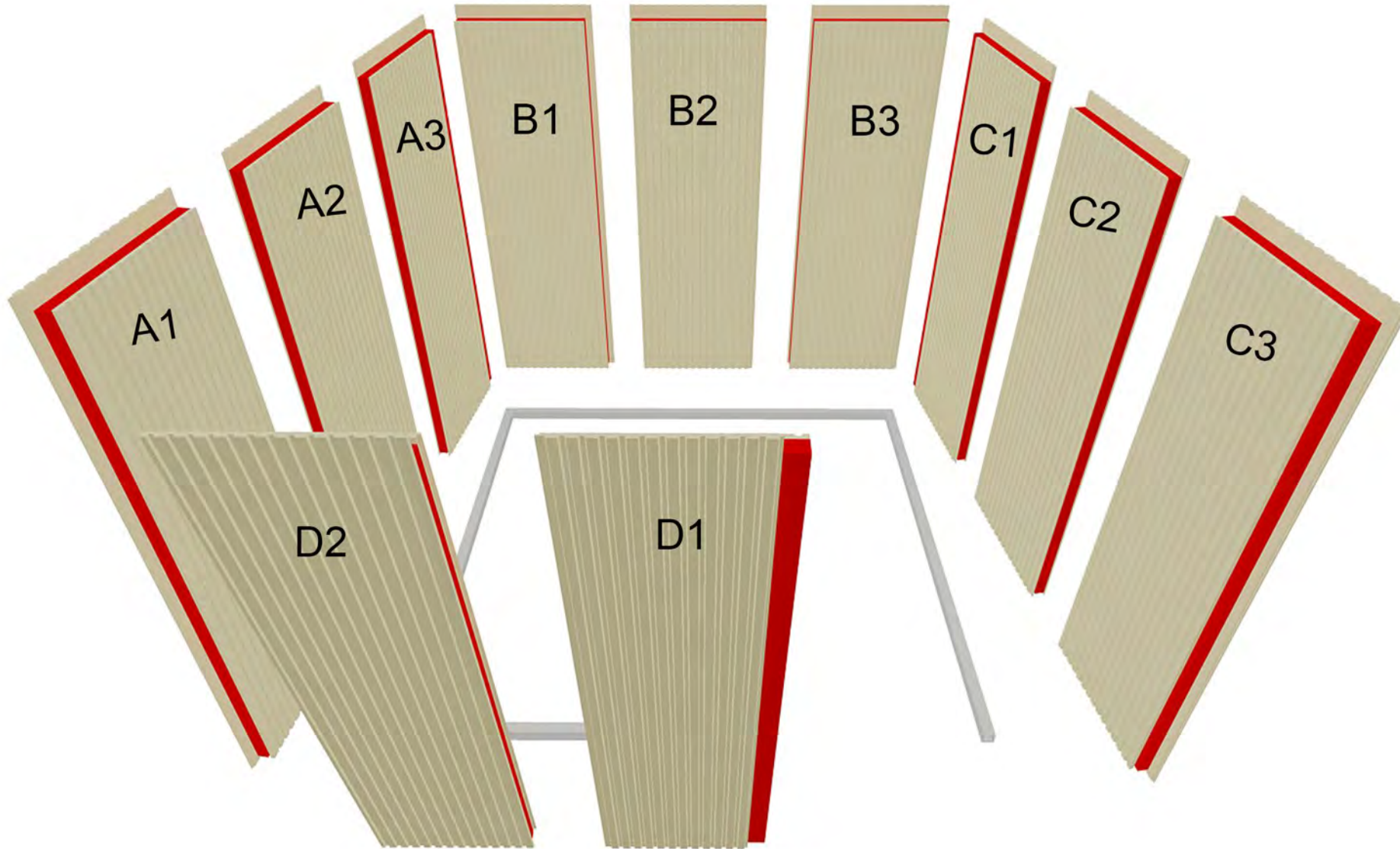

### 3. Multiclip closing system

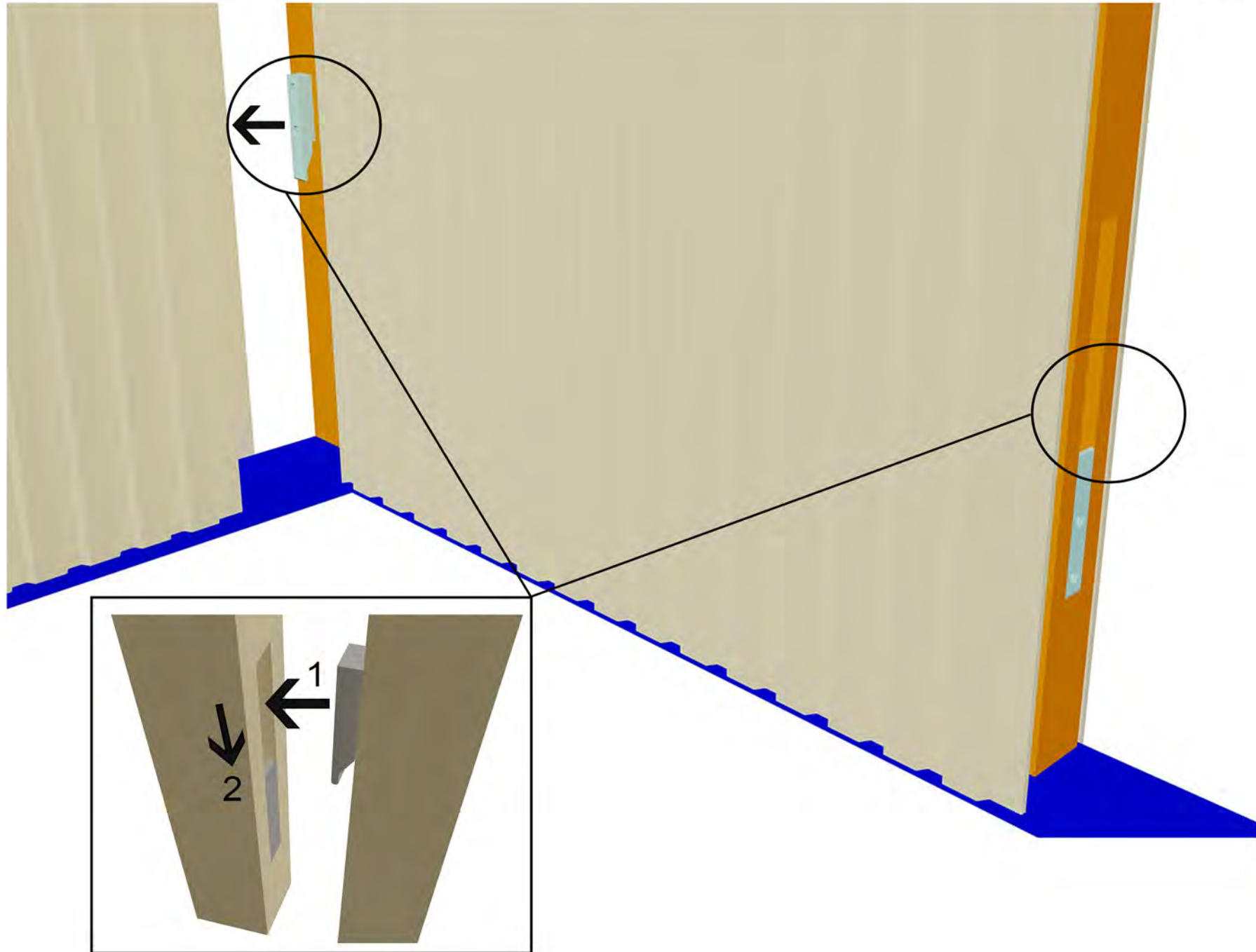

# 4. Fixing first corner walls

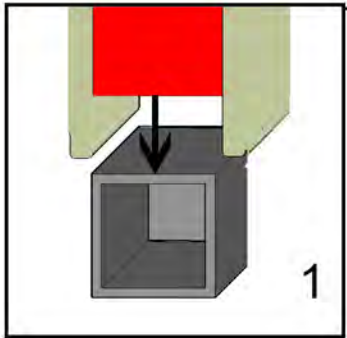
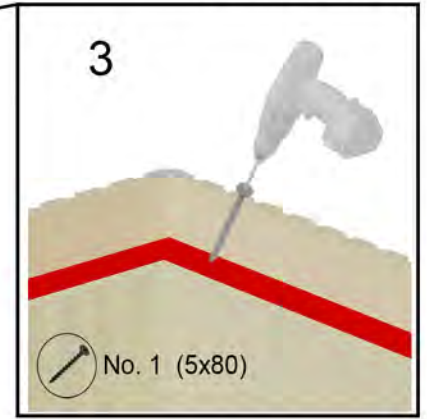
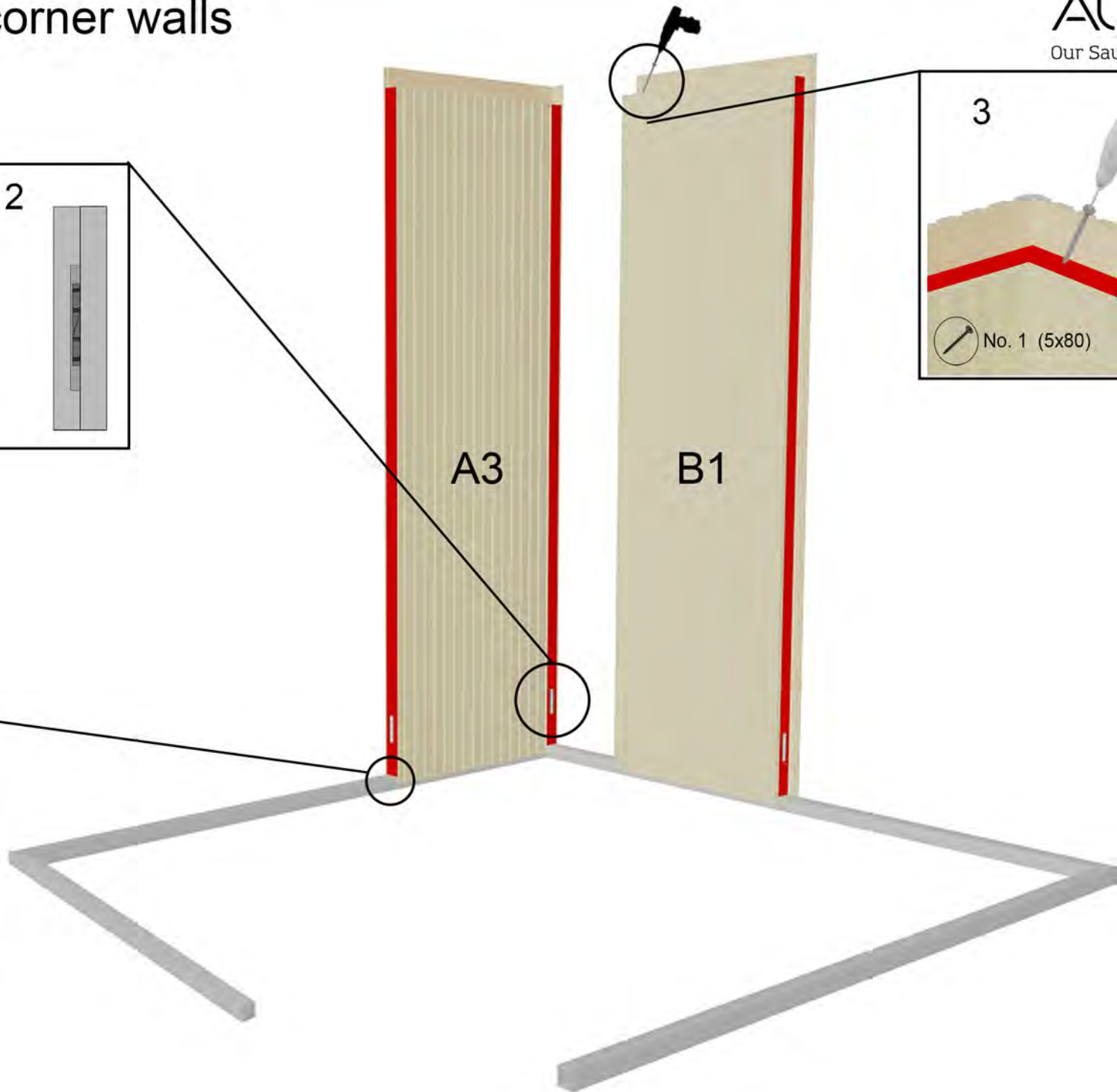
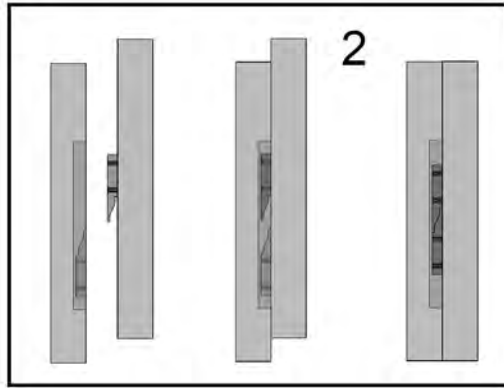

# 5. Fixing walls A1 & A2

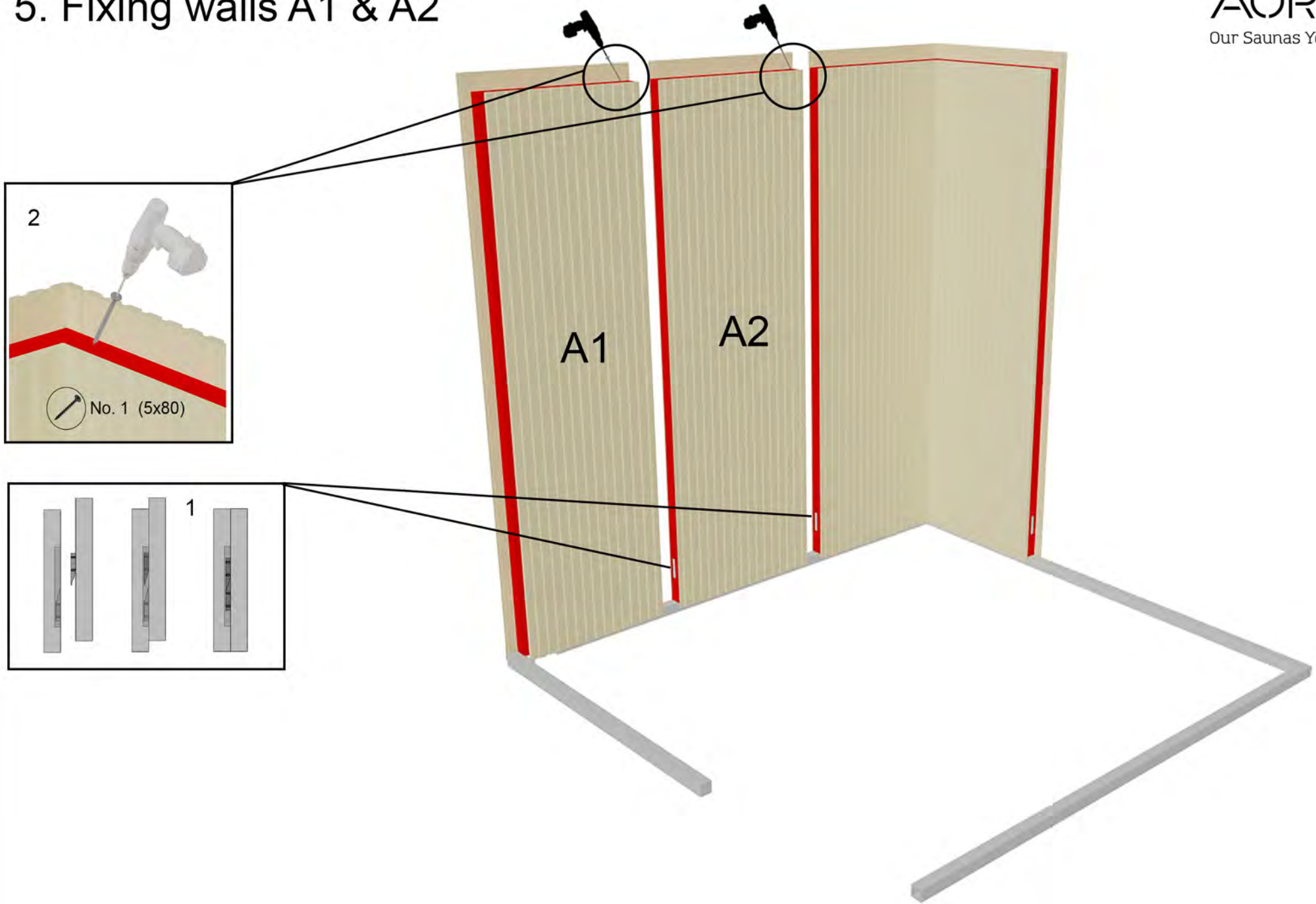

## 6. Fixing walls B2 & B3

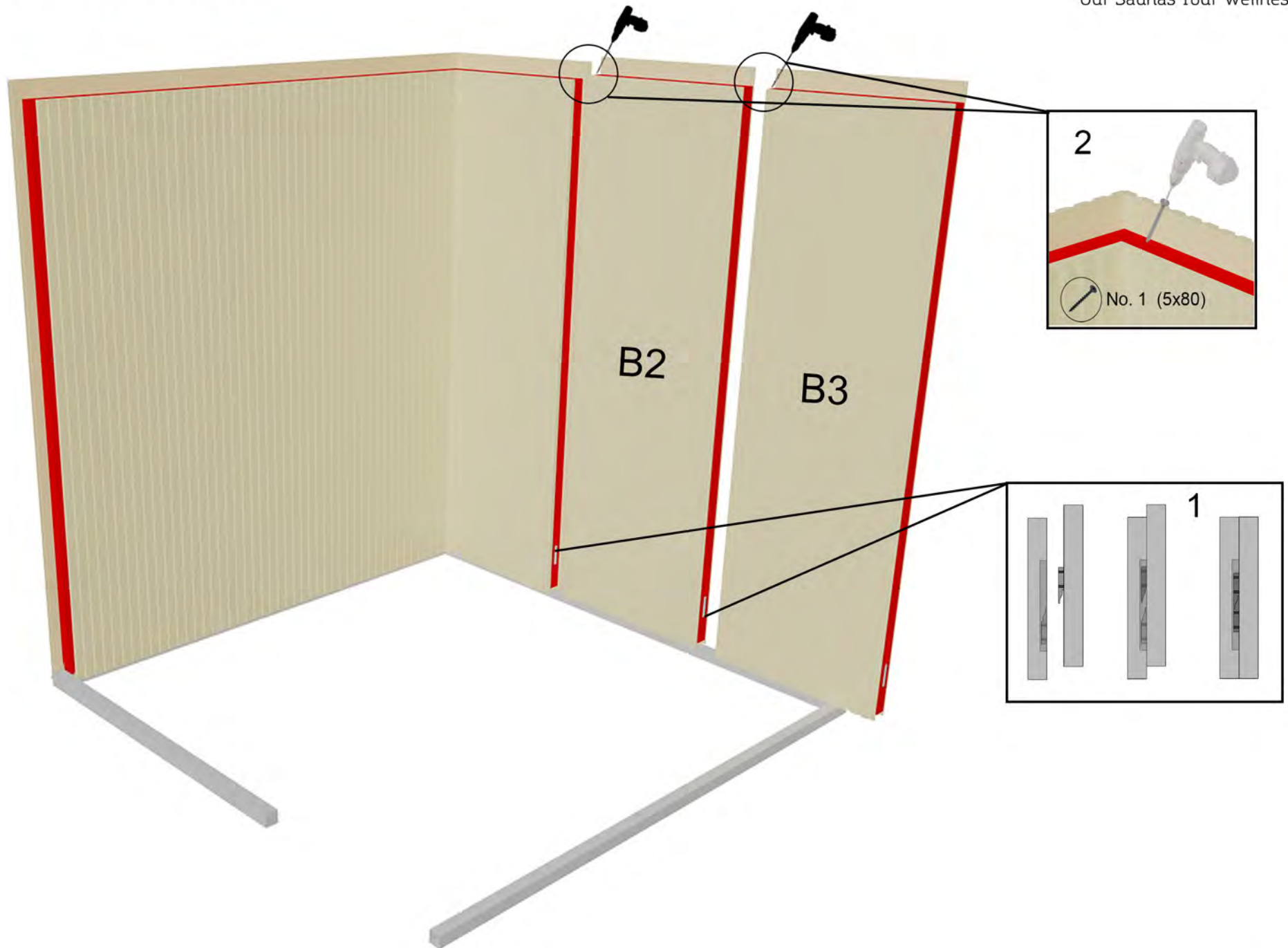

# 7. Fixing walls C1 & C2 & C3

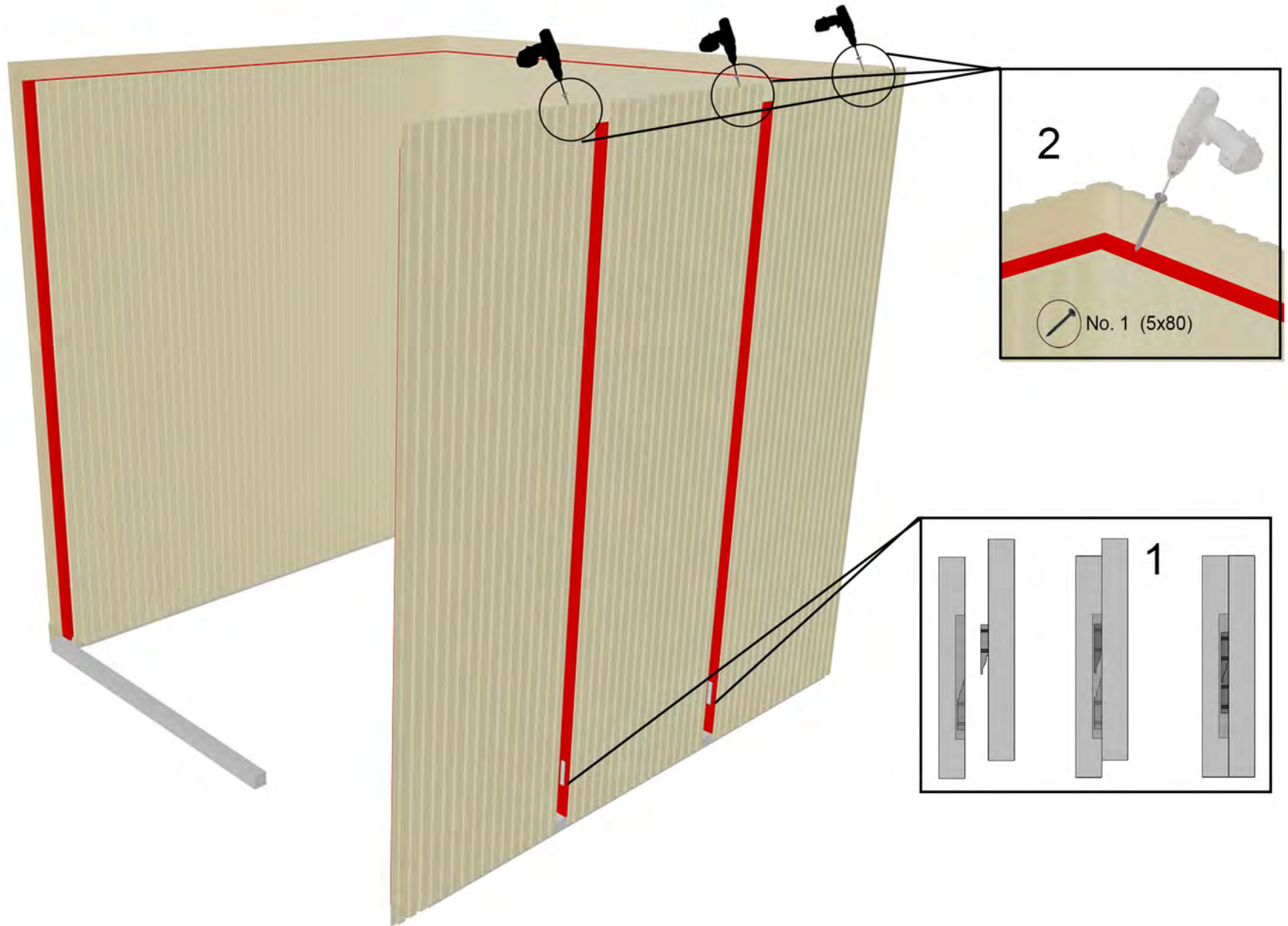

# 8. Fixing walls D1 & D2

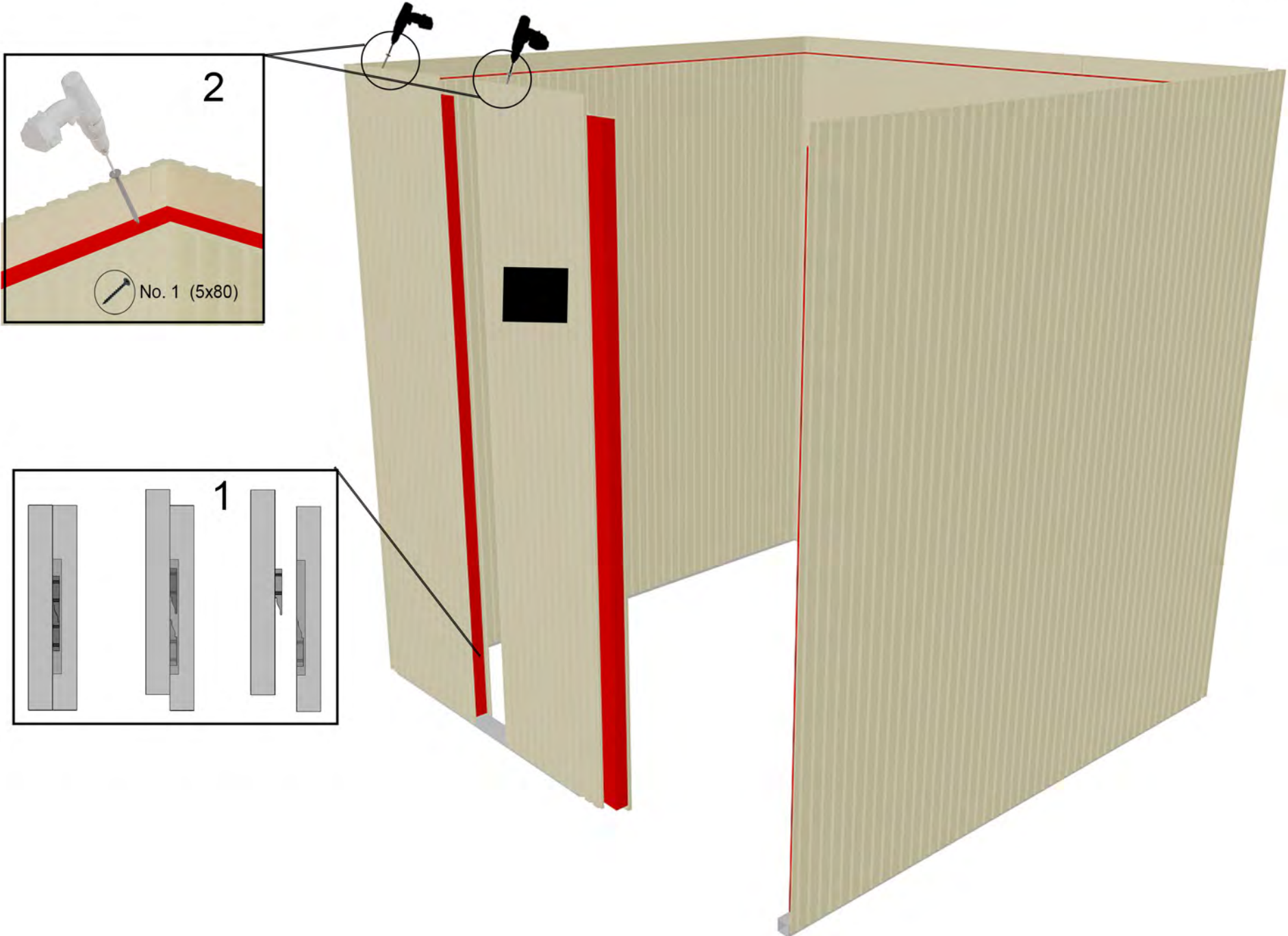

# 9. Fixing ceilings

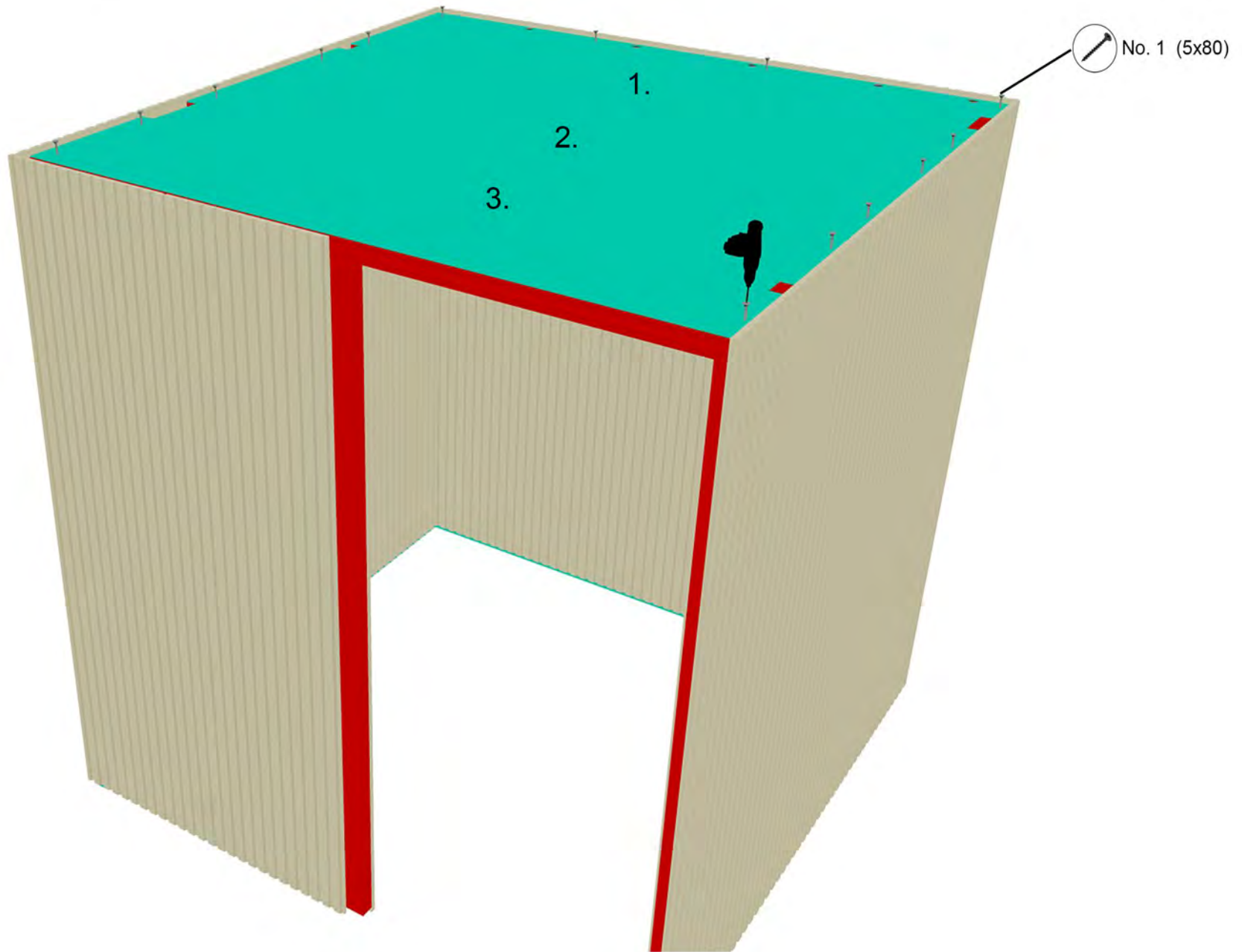

10. Interior  
150x180 cm  
150x200 cm  
200x200 cm

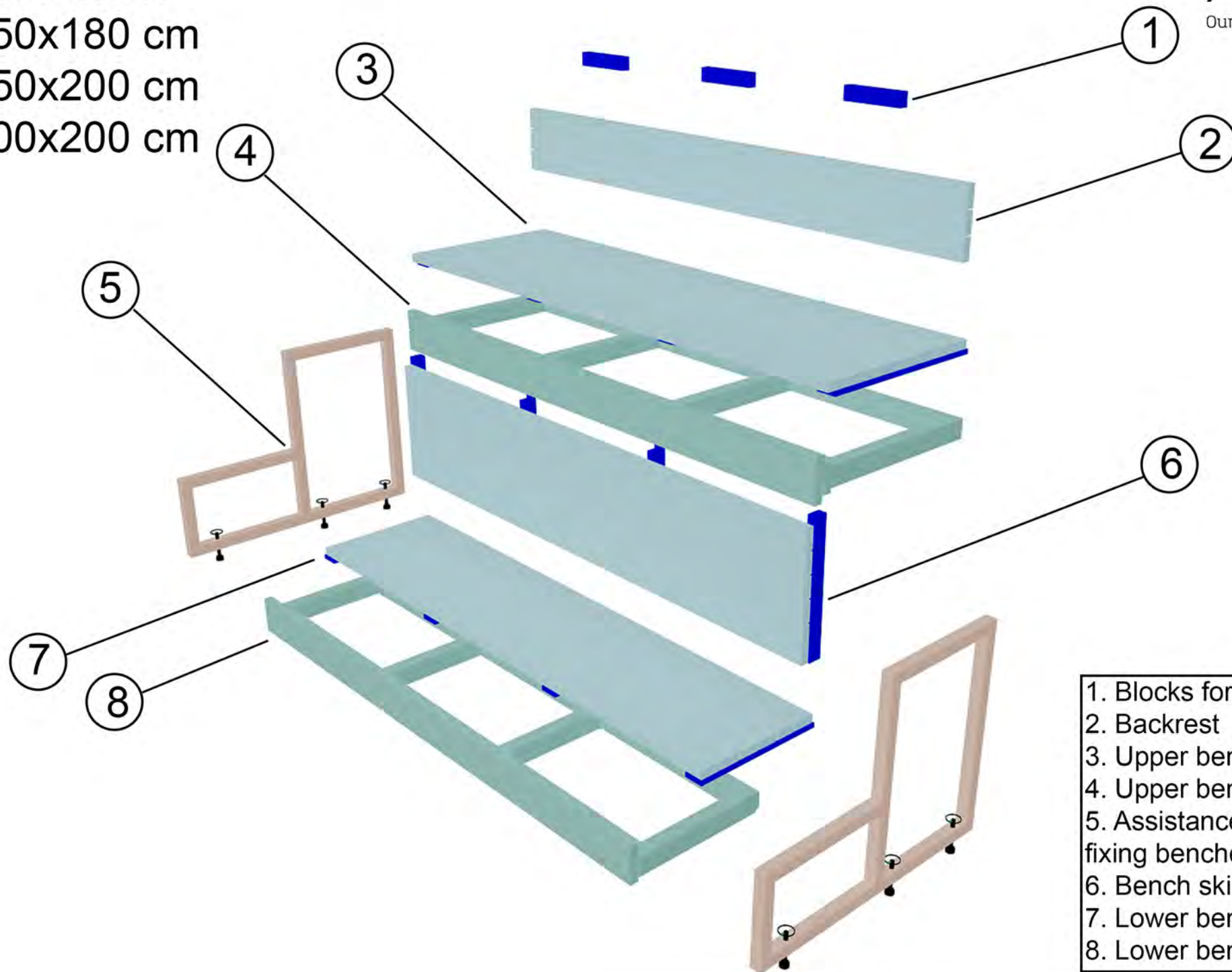

1. Blocks for fixing backrest
2. Backrest
3. Upper bench grid
4. Upper bench frame
5. Assistance frames for fixing benches
6. Bench skirt
7. Lower bench grid
8. Lower bench frame

# 10.1 Interior 120x180 cm

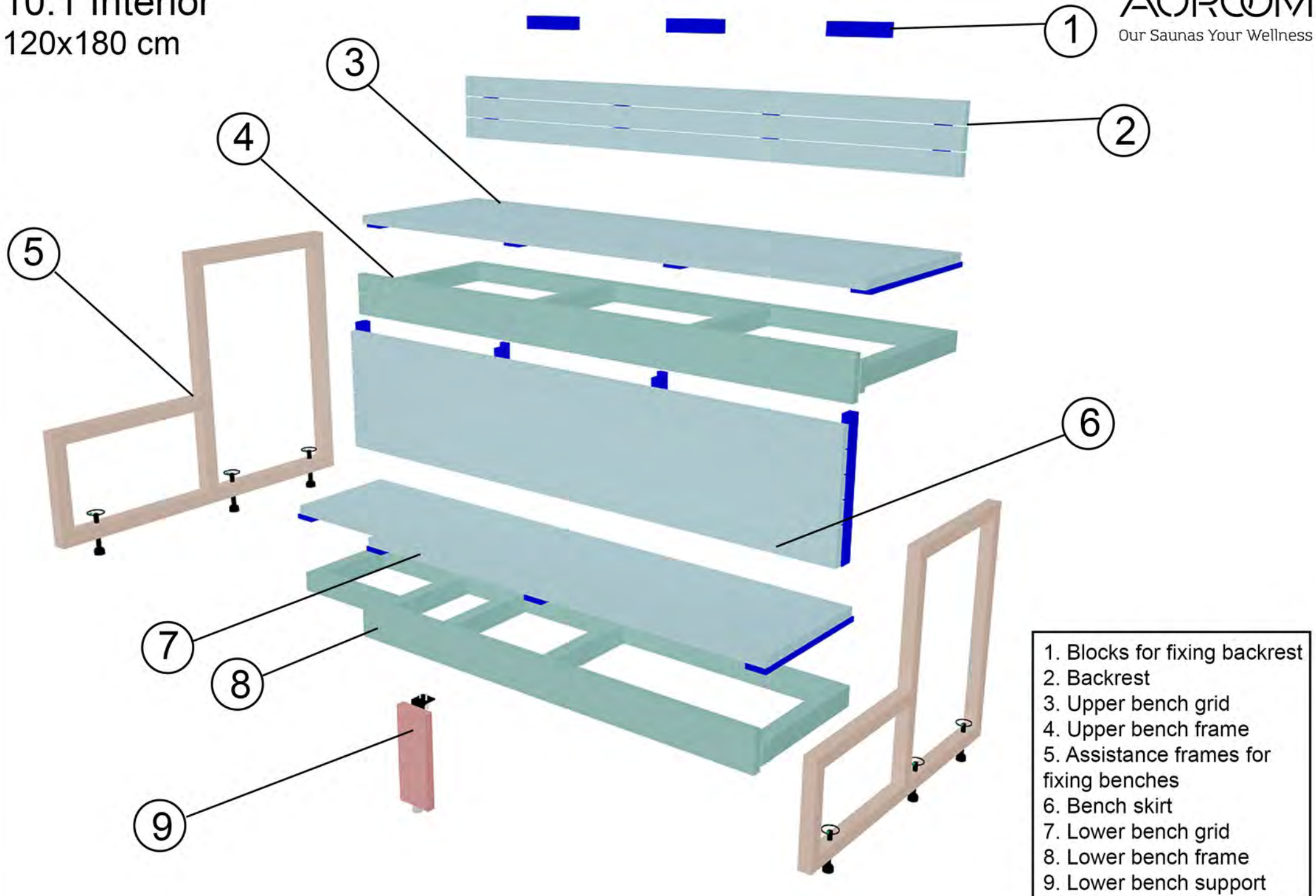

- 1. Blocks for fixing backrest
- 2. Backrest
- 3. Upper bench grid
- 4. Upper bench frame
- 5. Assistance frames for fixing benches
- 6. Bench skirt
- 7. Lower bench grid
- 8. Lower bench frame
- 9. Lower bench support

## 10.2 Interior 200x250 cm

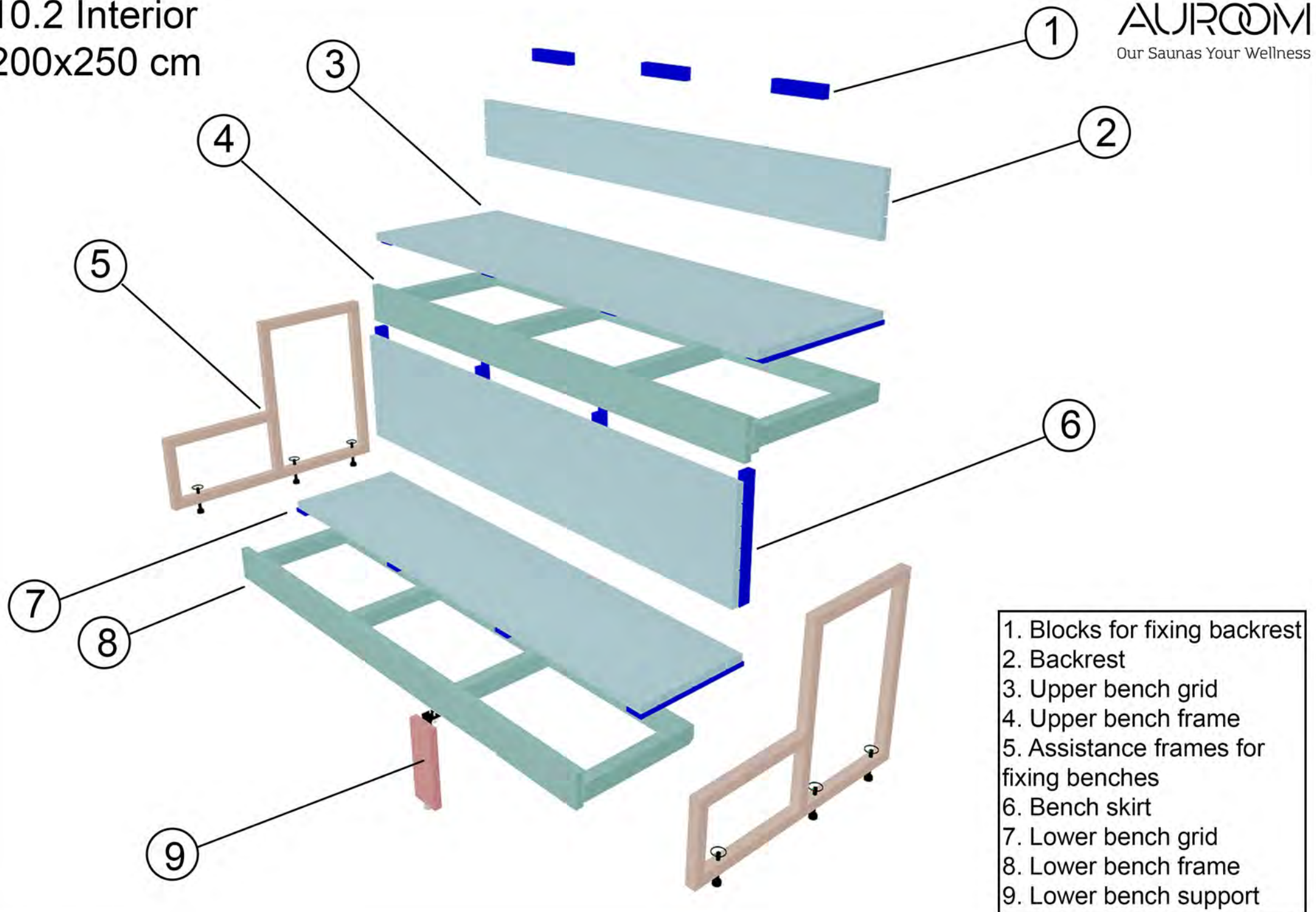

1. Blocks for fixing backrest
2. Backrest
3. Upper bench grid
4. Upper bench frame
5. Assistance frames for fixing benches
6. Bench skirt
7. Lower bench grid
8. Lower bench frame
9. Lower bench support

# 11. Assistance frames

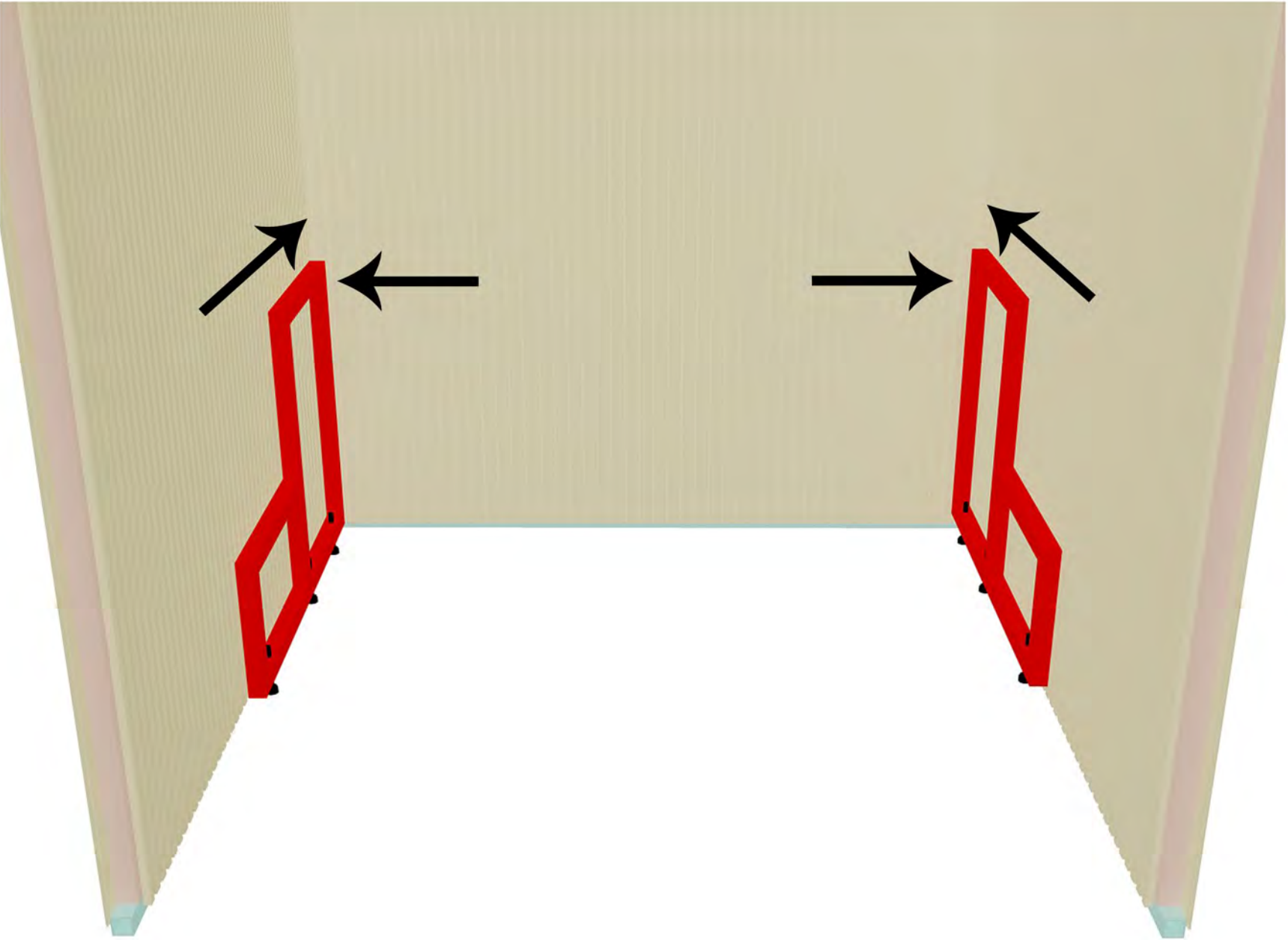

# 12. Bench support installing

120x180 cm

150x180 cm

150x200 cm

200x250 cm

Pre-marked stripes

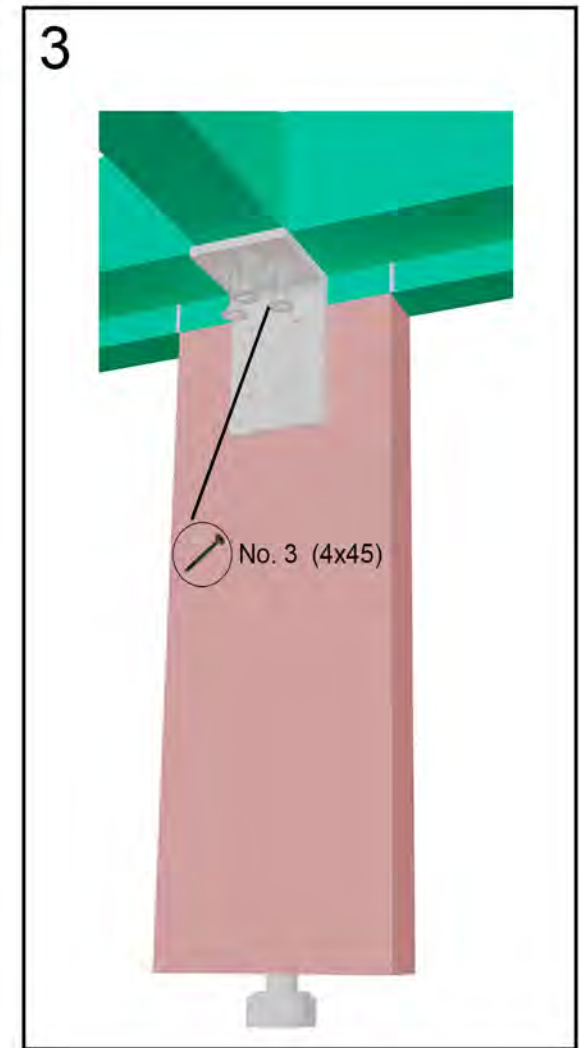
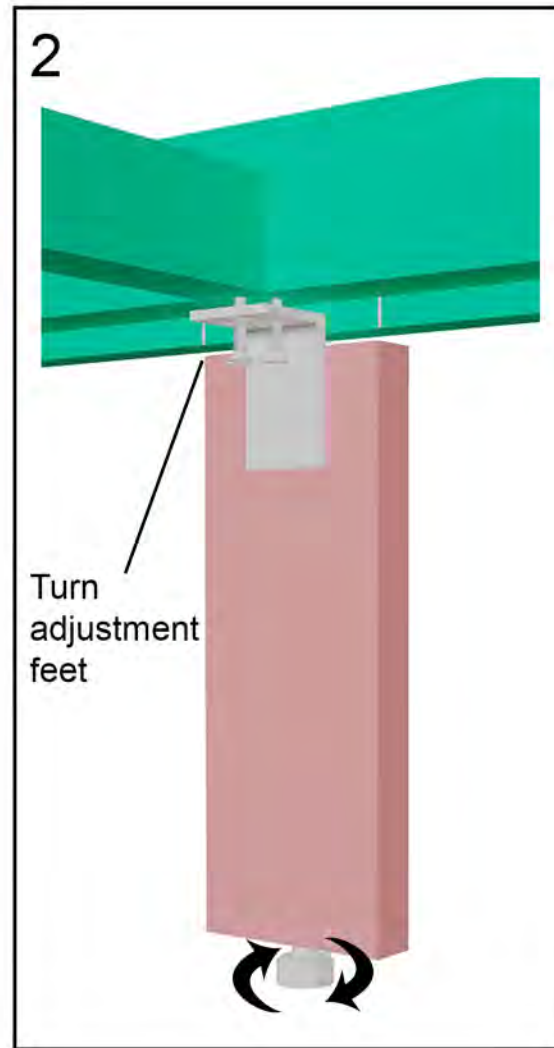
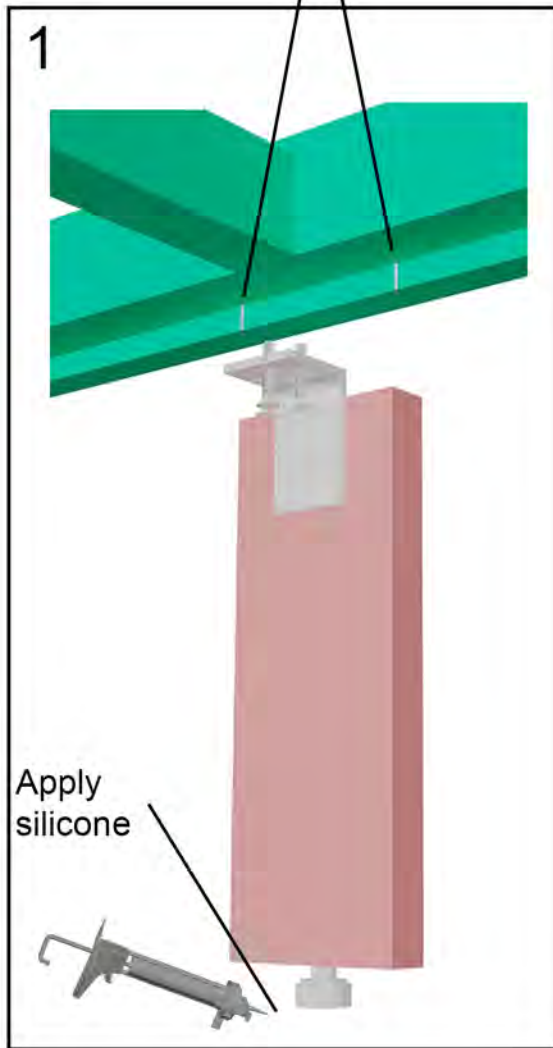

# 13. Bench frames and backrest blocks fixing

150x180 cm

150x200 cm

200x200 cm

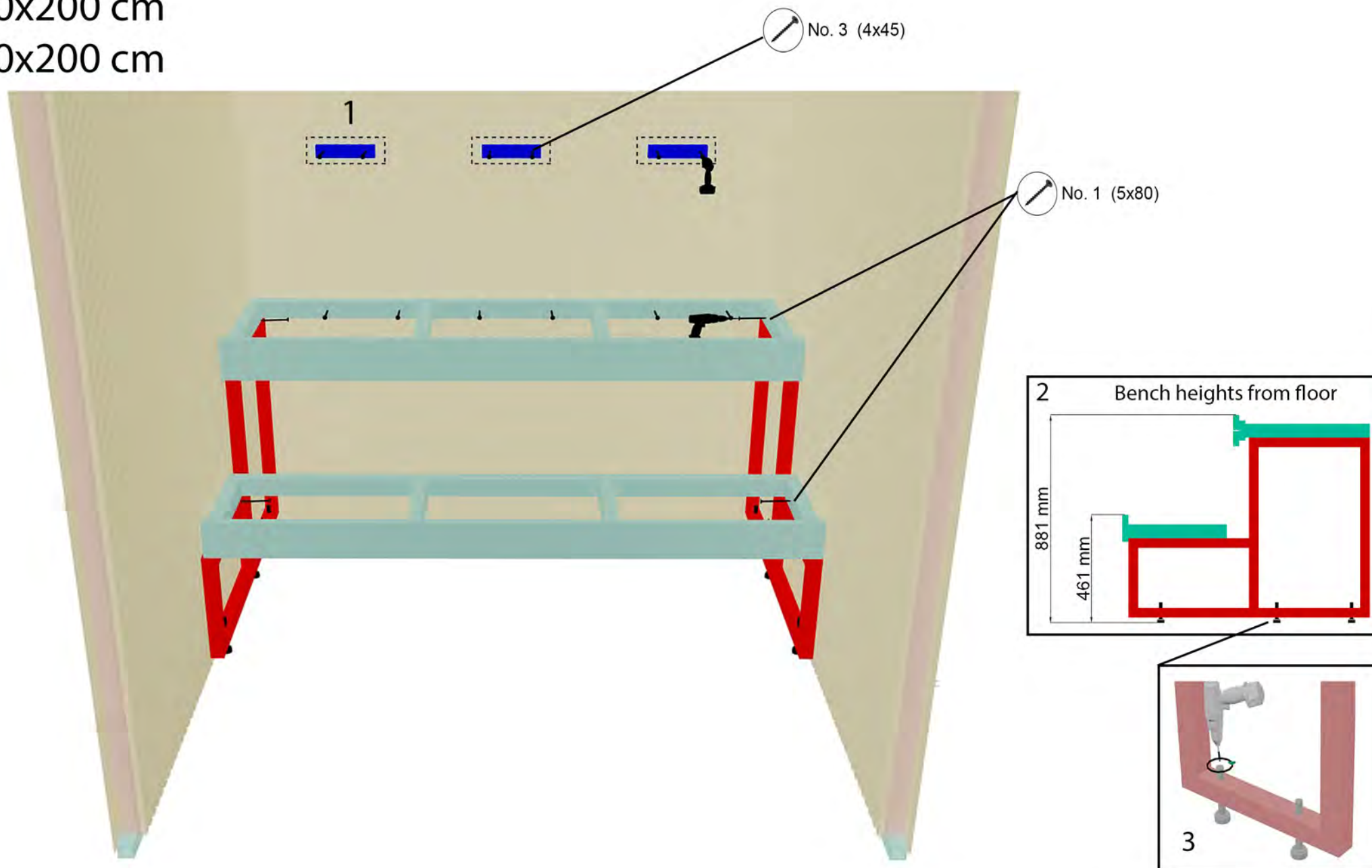

# 13.1 Bench frames and backrest blocks fixing 120x180 cm

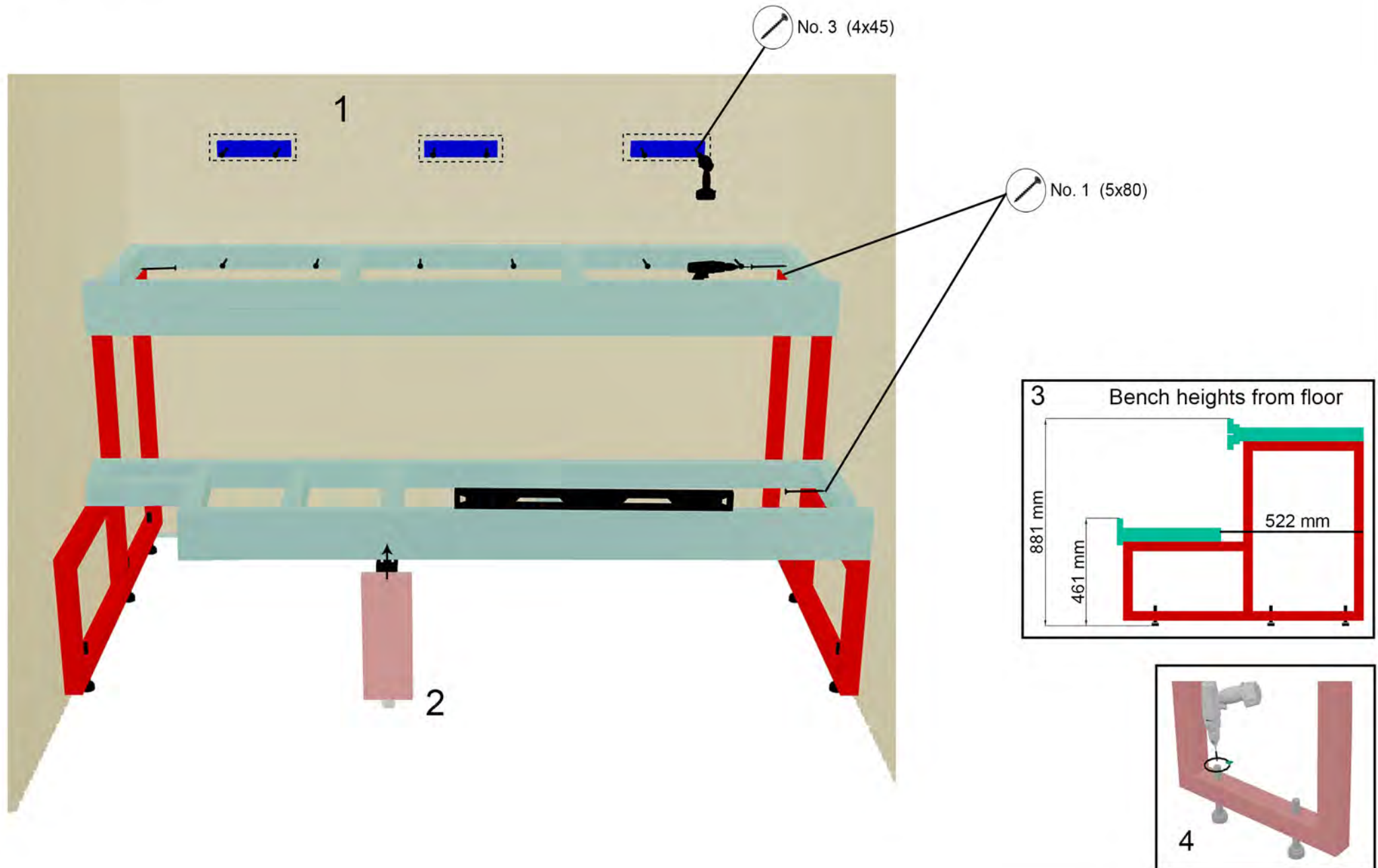

# 13.2 Bench frames and backrest blocks fixing 200x250 cm

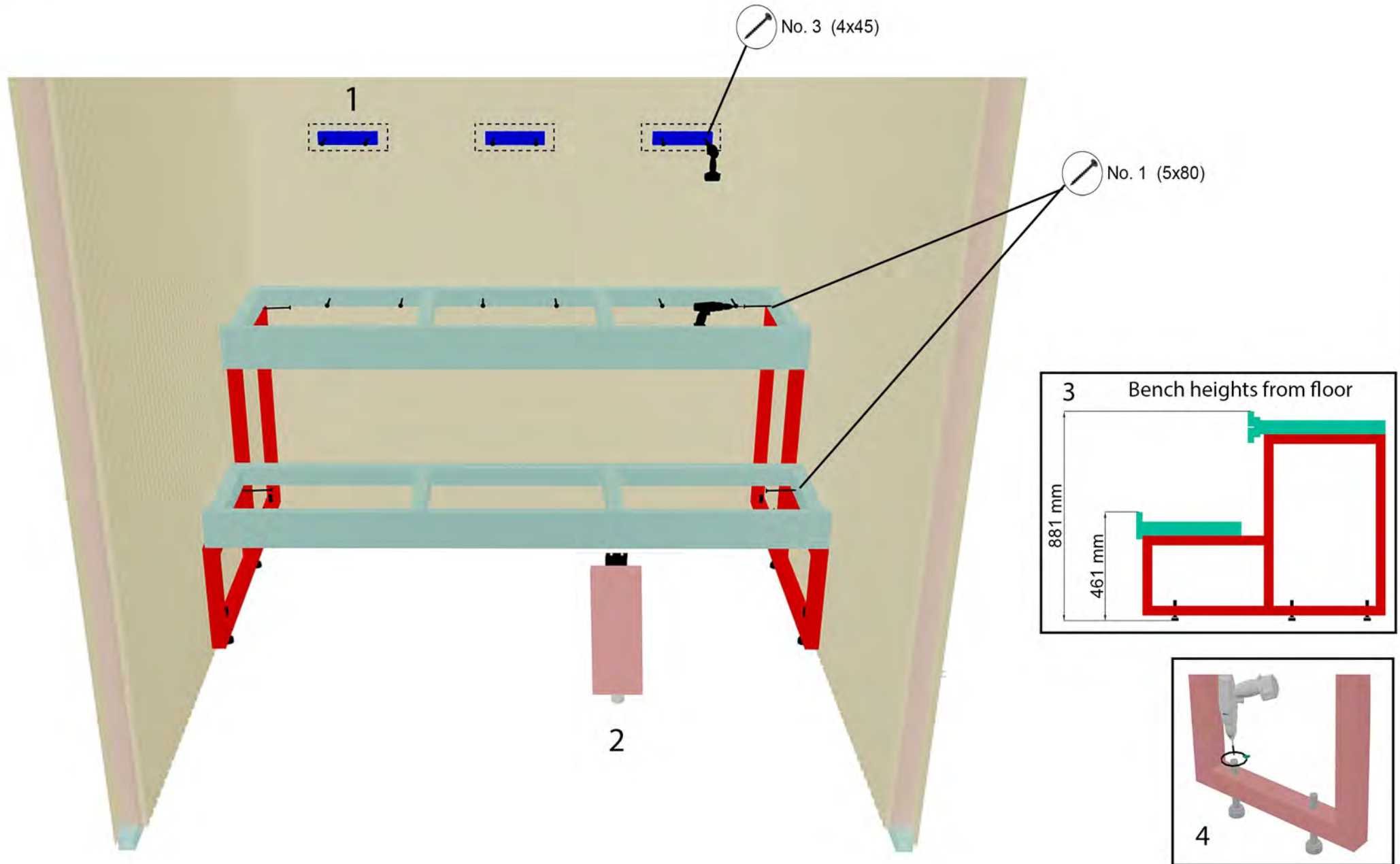

# 14. Removing assistance frames

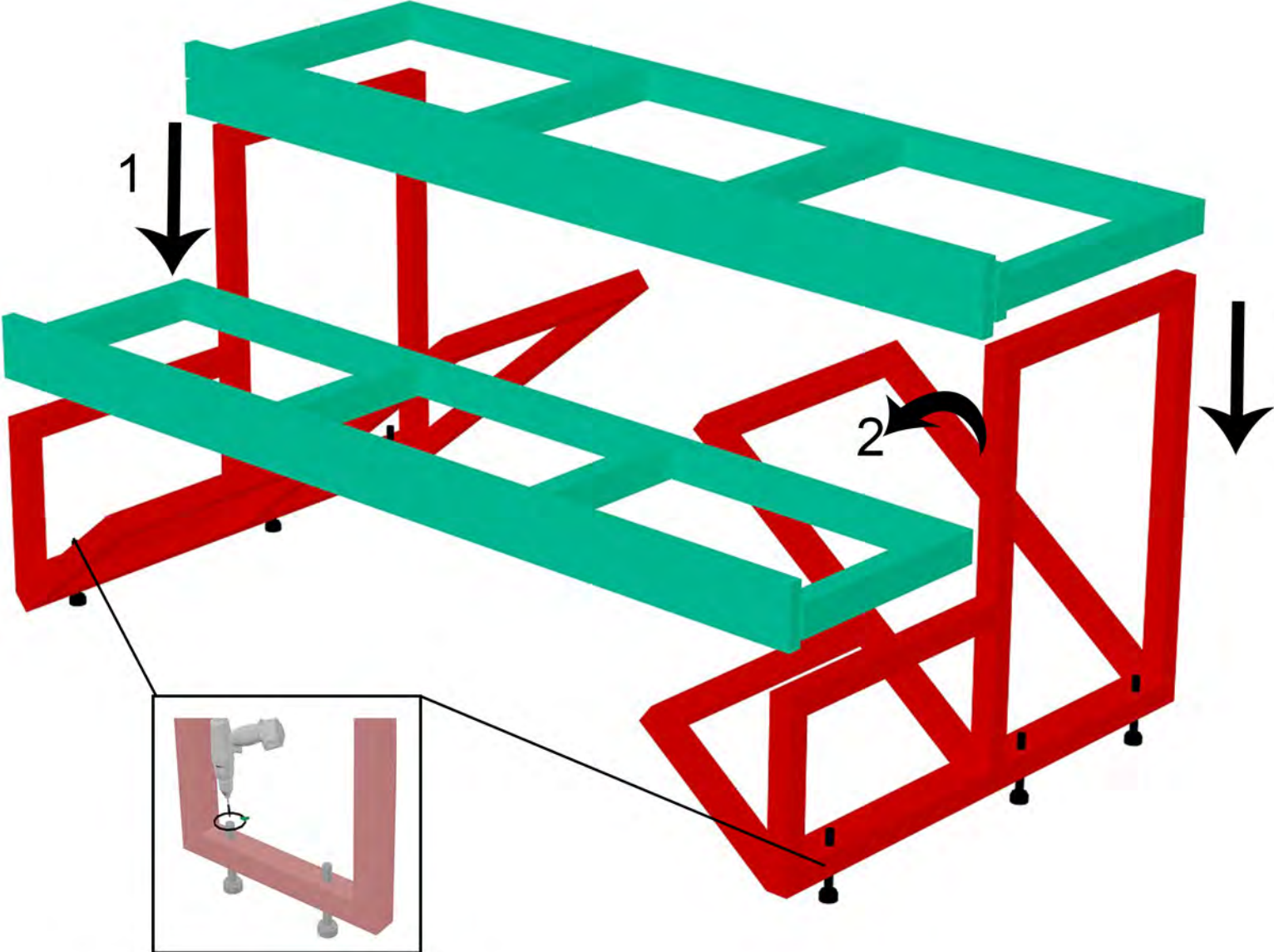

# 15. Wiring inside walls



1. Push down wires from precut holes on ceiling

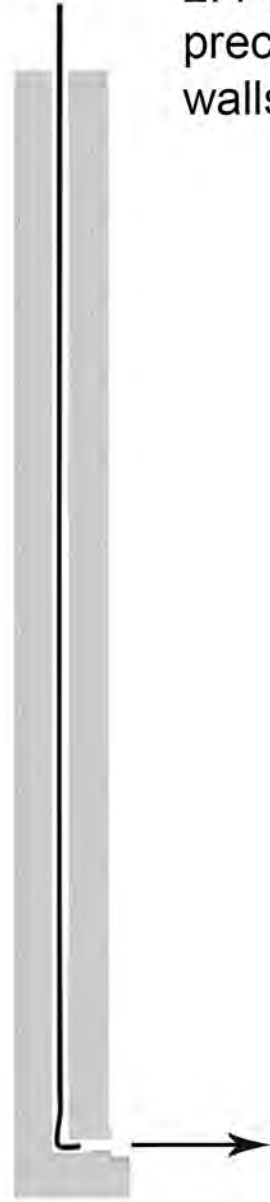

2. Pull out wires from precut holes in the walls

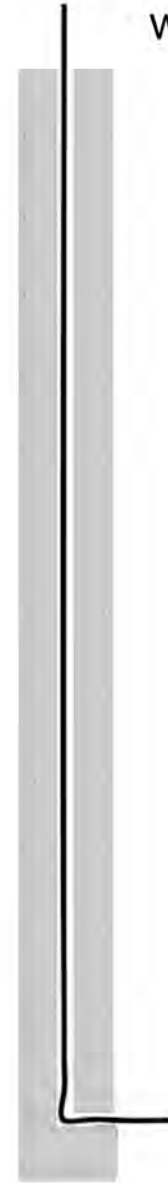

3. Connect wires

# 16. Connecting LED-strips

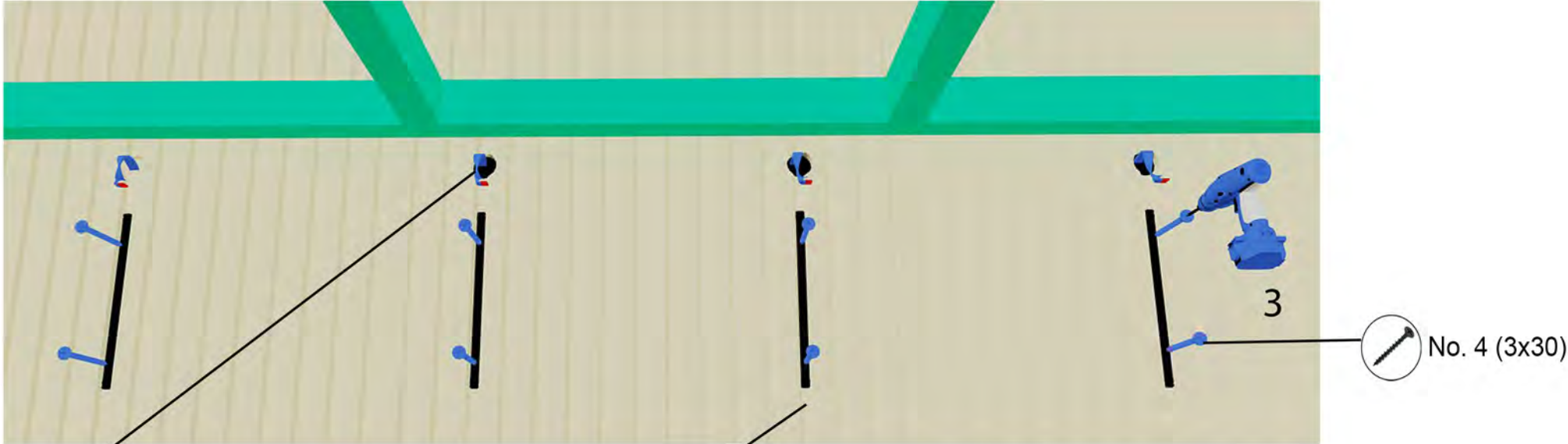

**!** Always use certified electrician

# 17. Fixing bench skirt

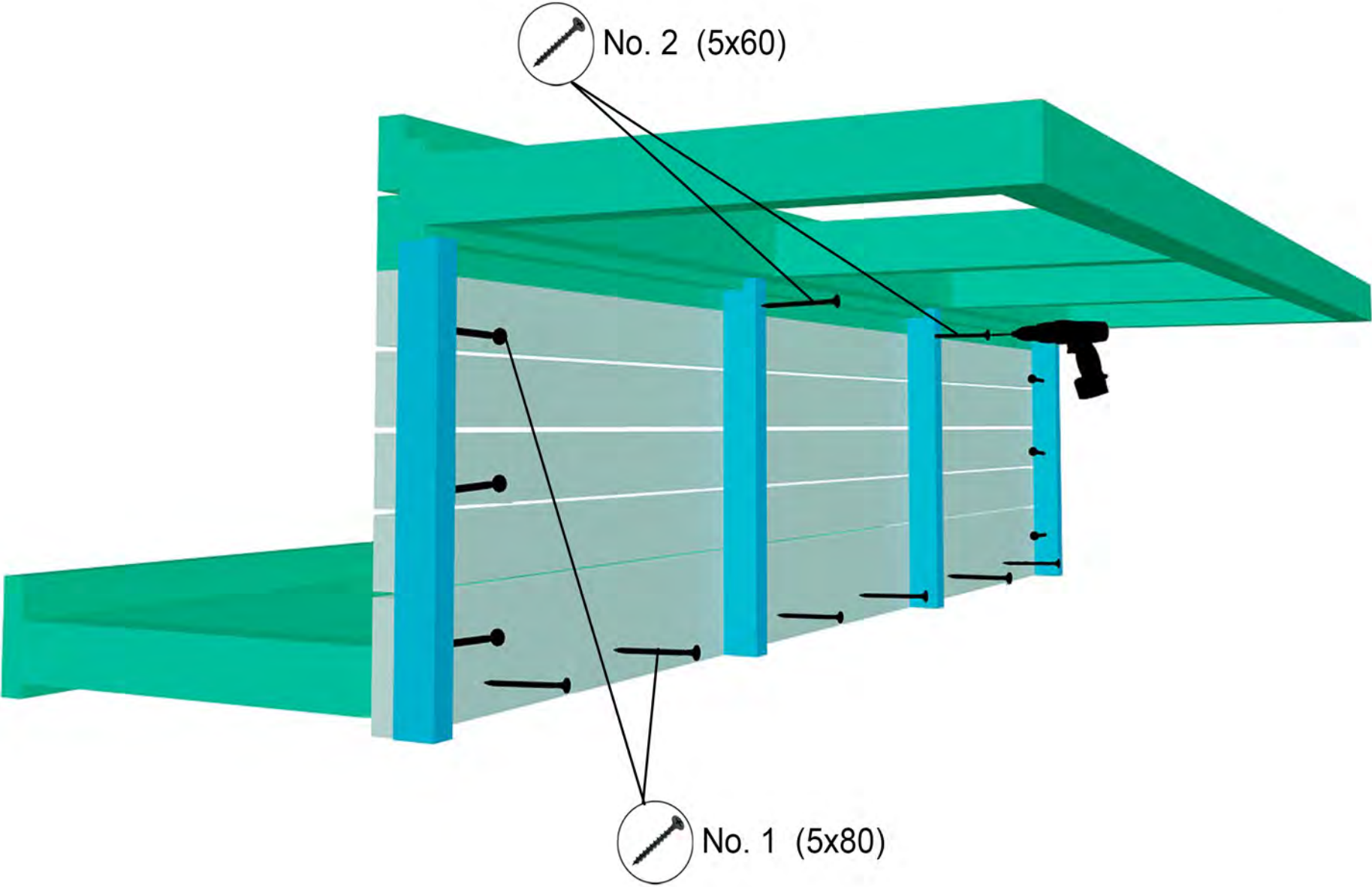

# 18. Backrest & bench grids

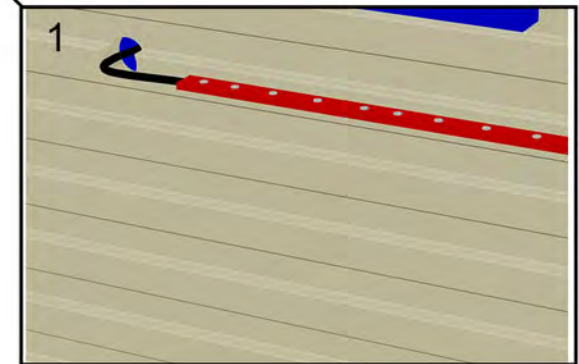
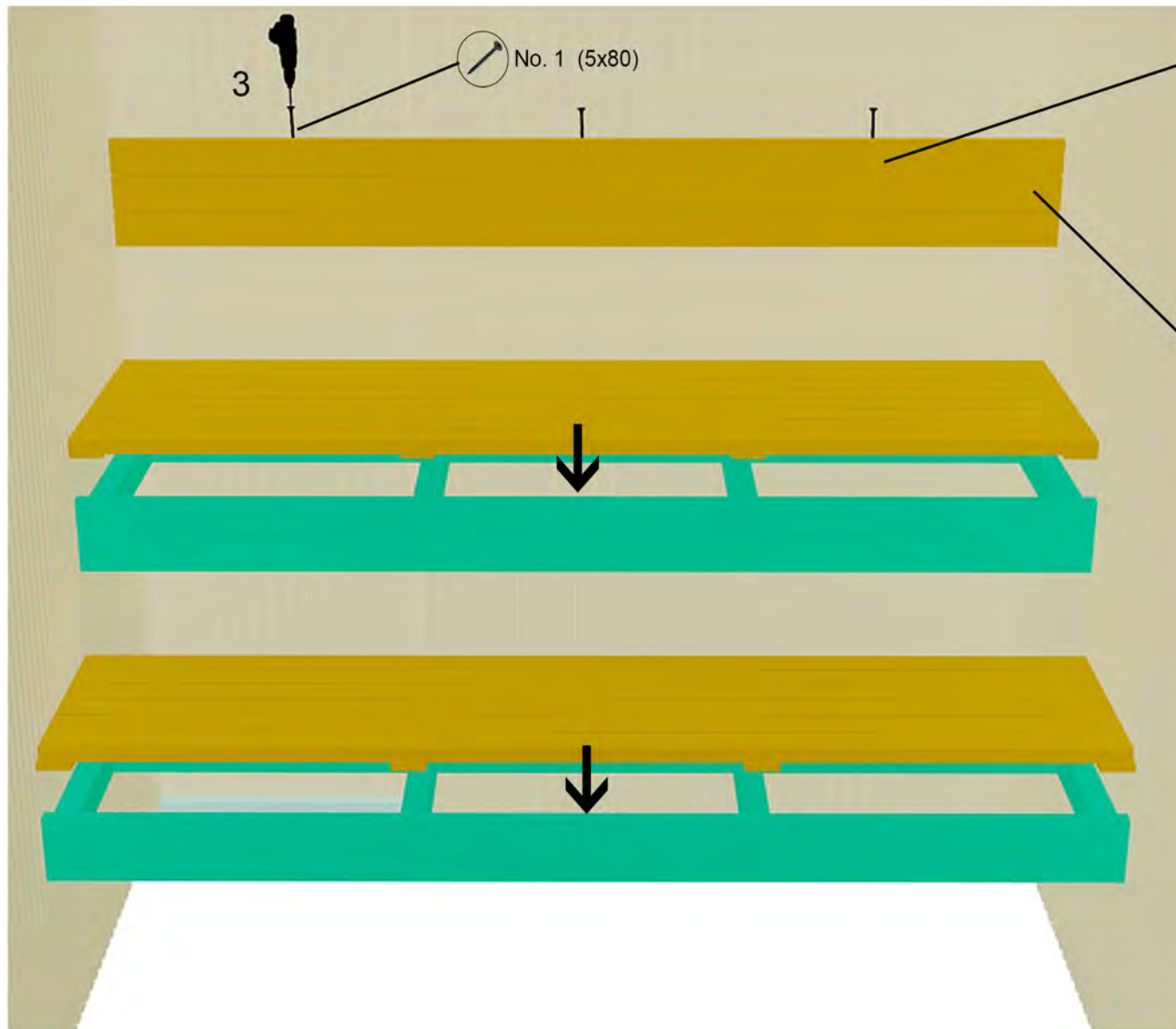

1. Push LED-strip cable to ceiling for connection
4. Fix LED-strip on top of backrest with glue (covering screws)

# 19. Interior II

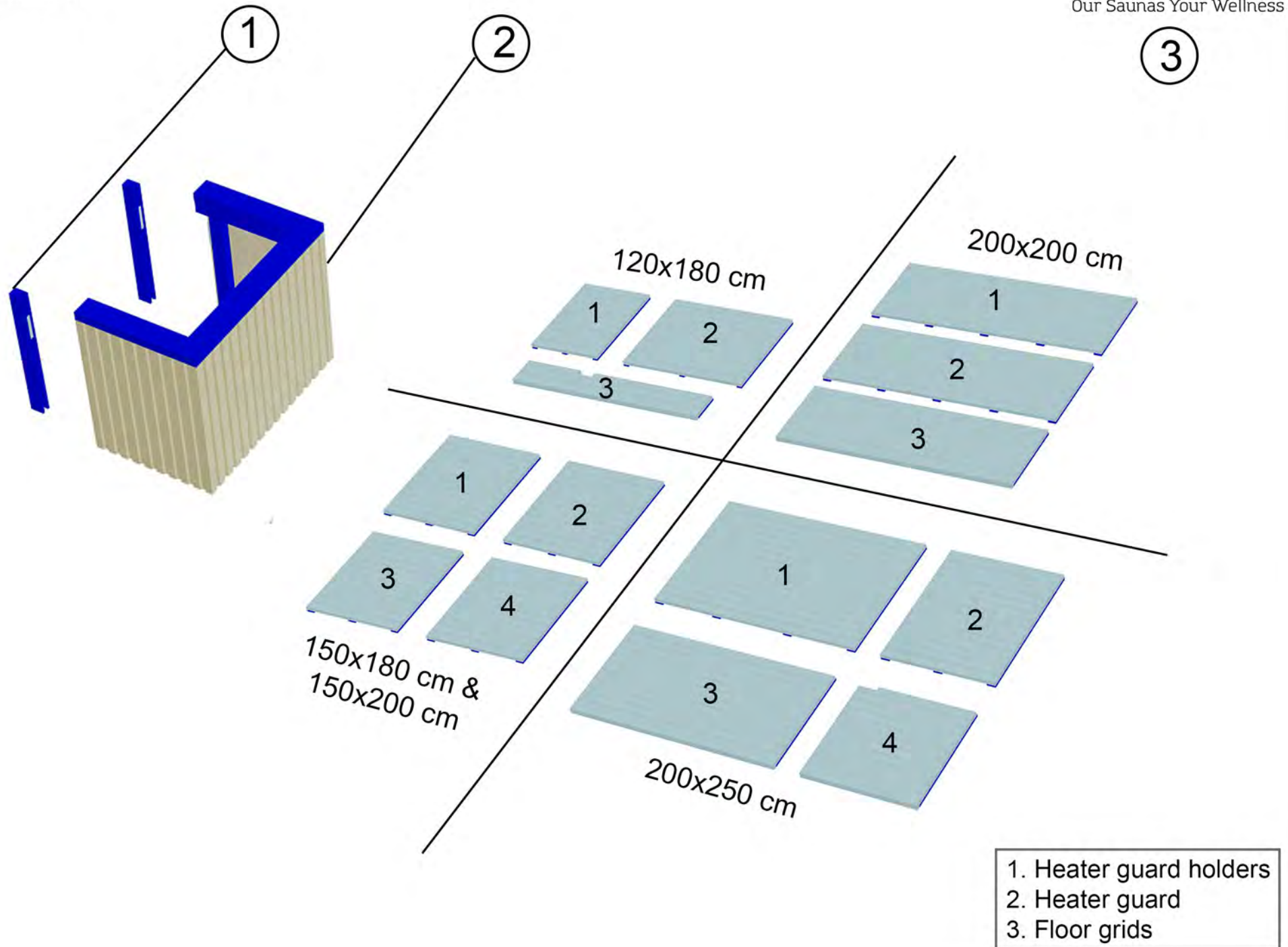

# 20. Heater guard

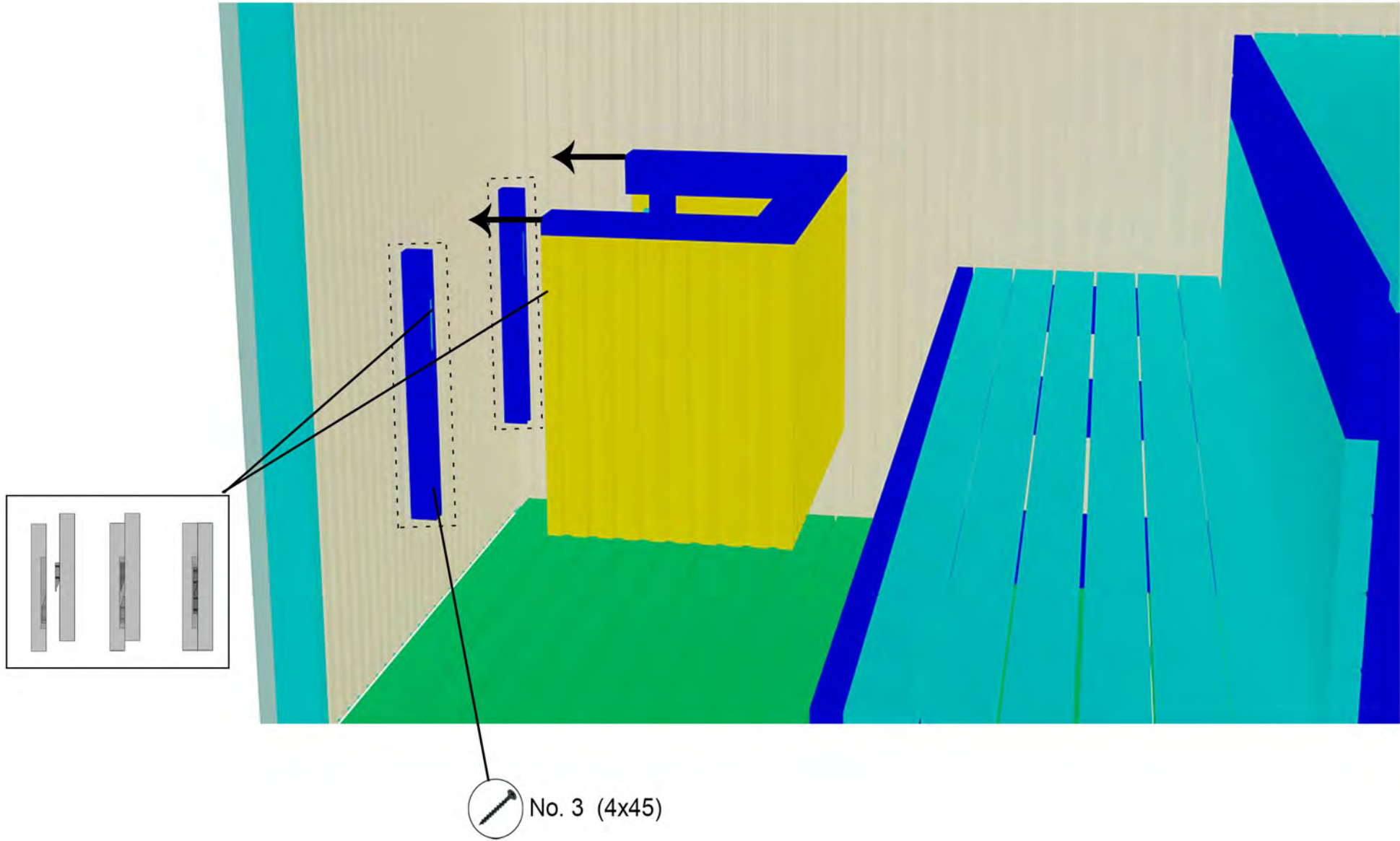

# 21. Door frames

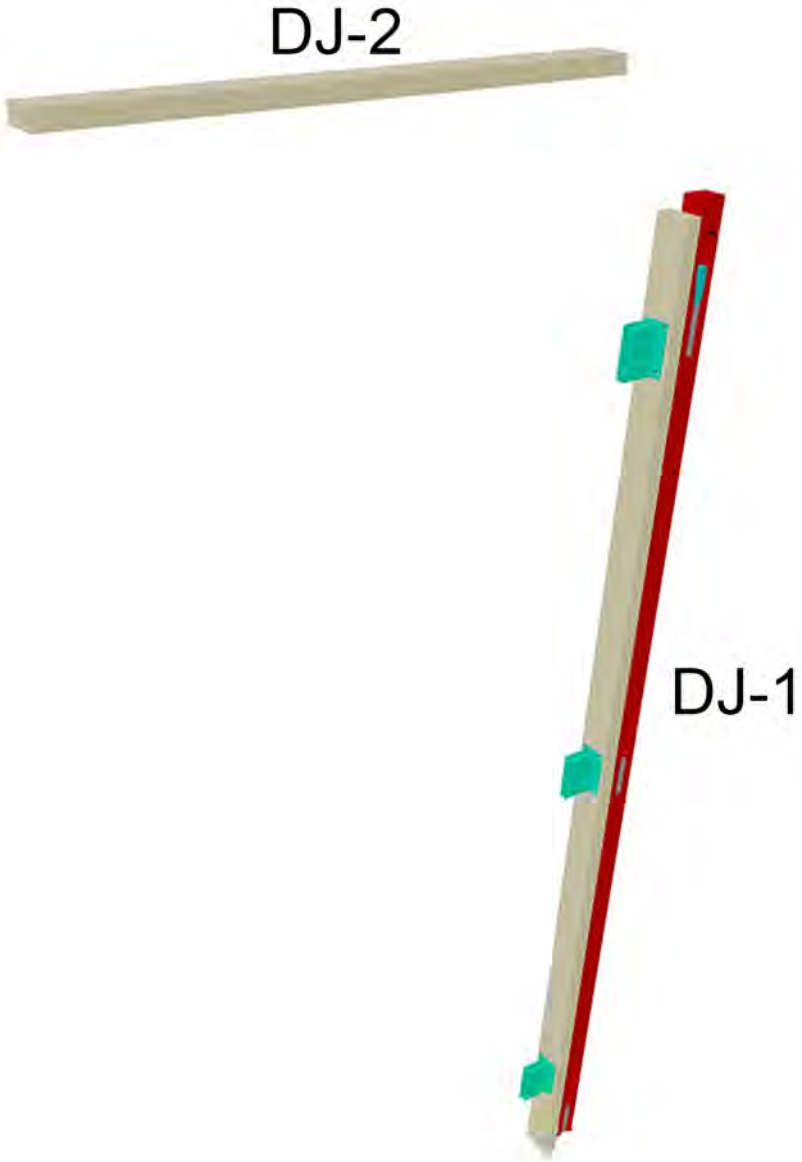

## 22. Fixing door frames

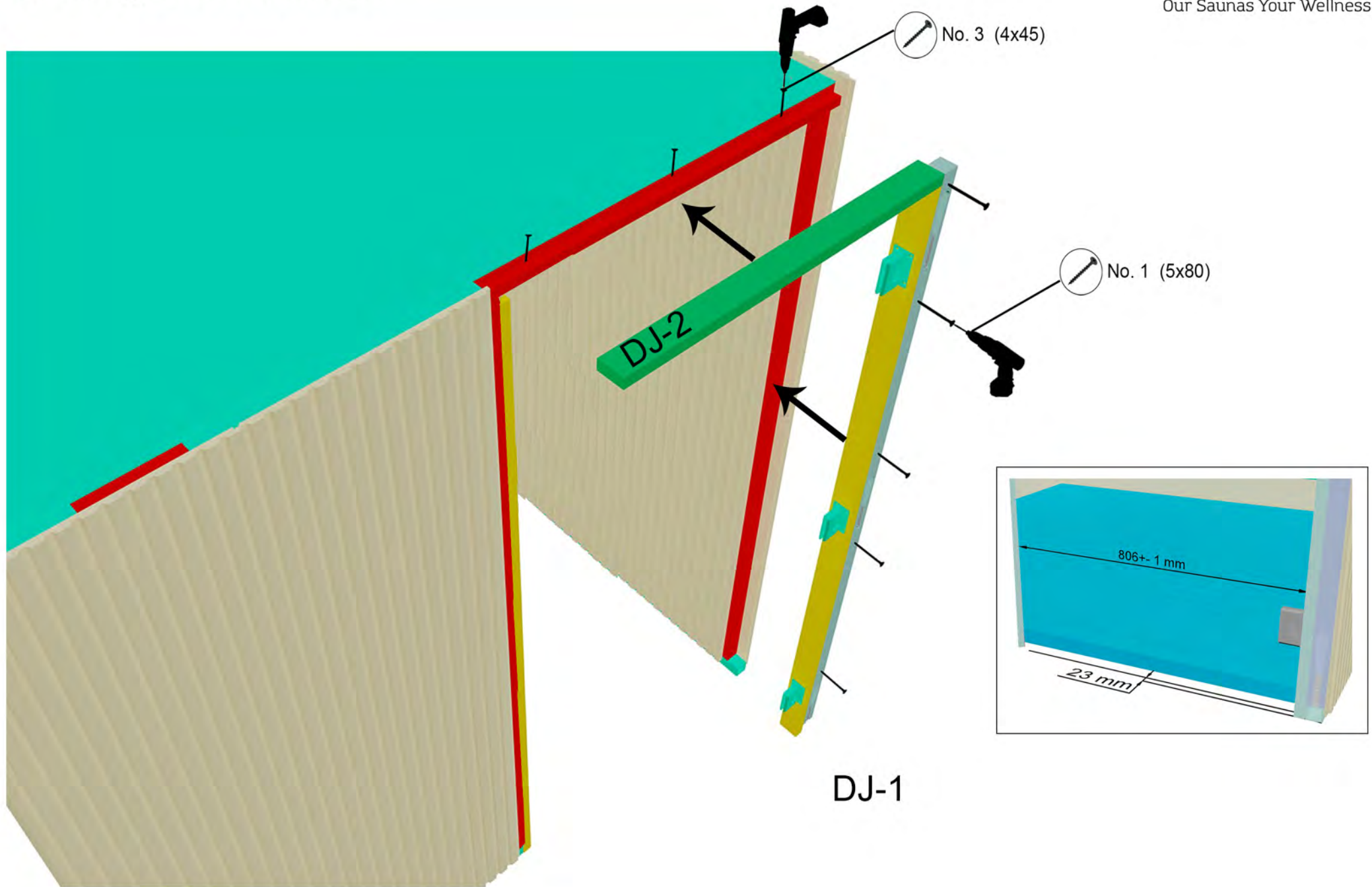

# 23. Front frame

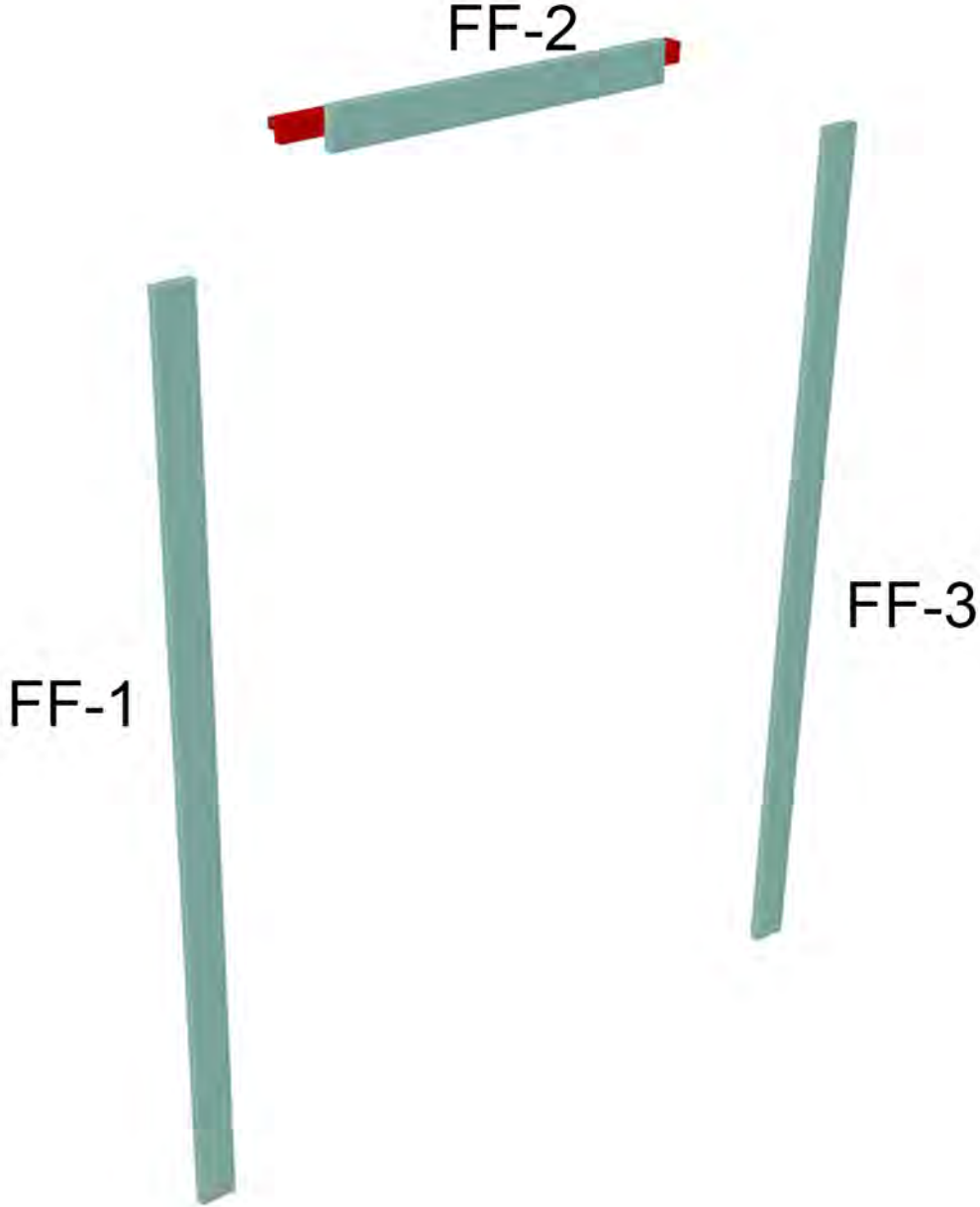

# 24. Fixing front frame

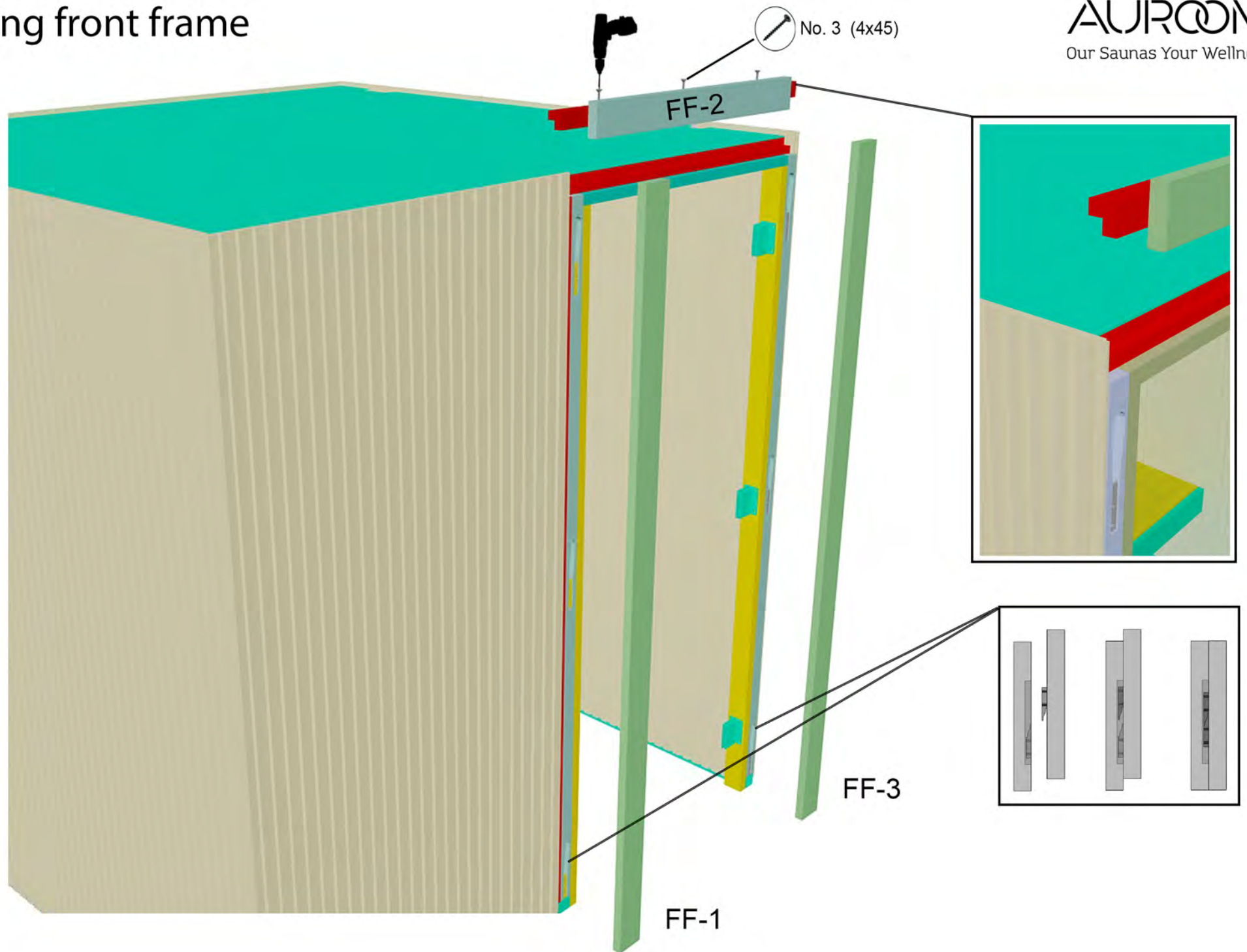

# 25. Door hinges and handle

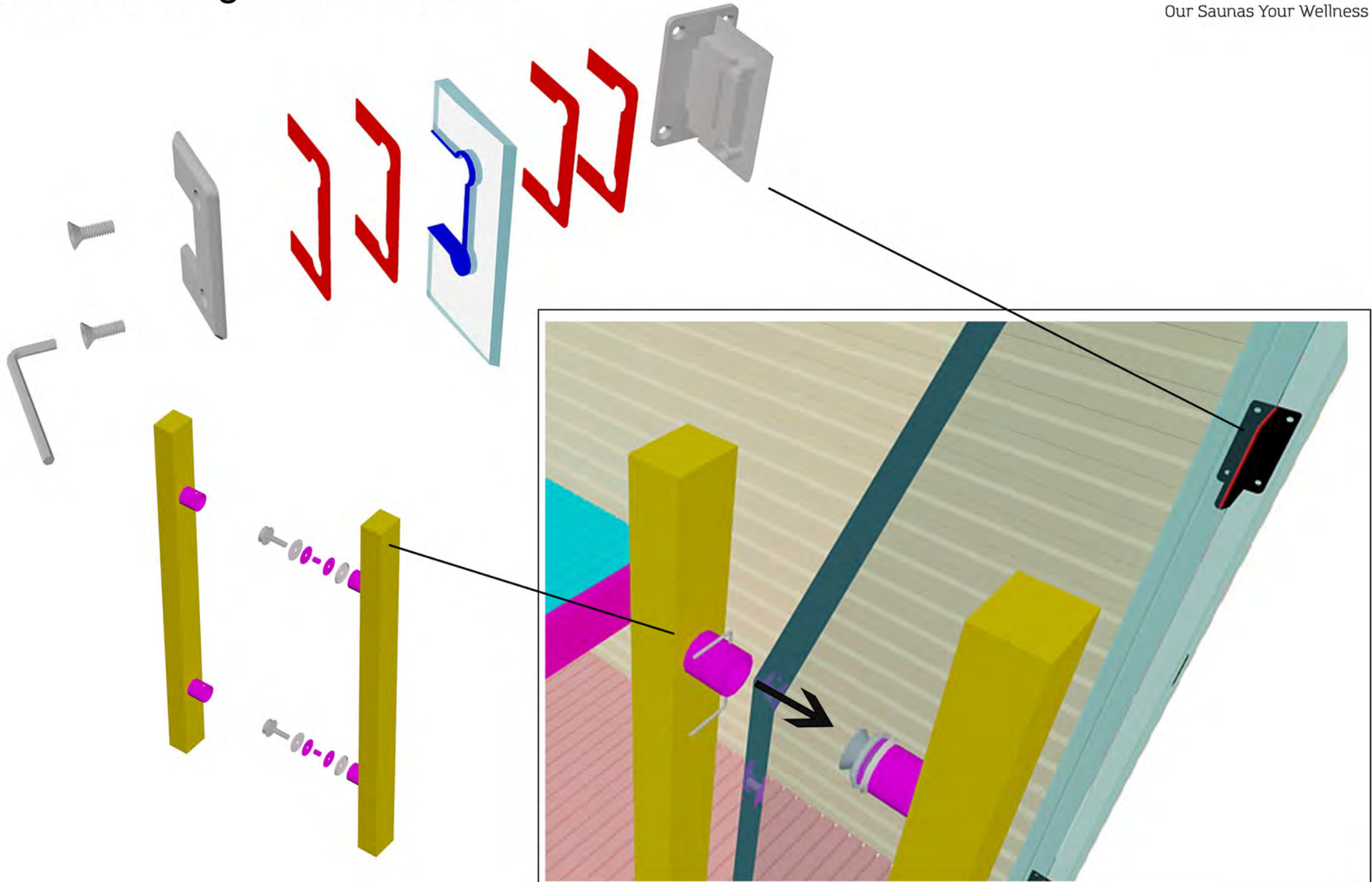

## 26. Wiring on ceiling

